

**LUDLUM MODEL 2241-3RK  
RESPONSE KIT**

**October 2017**

**Serial Number 238342 and Succeeding  
Serial Numbers**

**LUDLUM MODEL 2241-3RK  
RESPONSE KIT**

**October 2017**

**Serial Number 238342 and Succeeding  
Serial Numbers**



**LUDLUM MEASUREMENTS, INC**  
501 OAK STREET, P.O. BOX 810  
SWEETWATER, TEXAS 79556  
325-235-5494, FAX: 325-235-4672

**STATEMENT OF WARRANTY**

Ludlum Measurements, Inc. warrants the products covered in this manual to be free of defects due to workmanship, material, and design for a period of twelve months from the date of delivery. The calibration of a product is warranted to be within its specified accuracy limits at the time of shipment. In the event of instrument failure, notify Ludlum Measurements to determine if repair, recalibration, or replacement is required.

This warranty excludes the replacement of photomultiplier tubes, G-M and proportional tubes, and scintillation crystals which are broken due to excessive physical abuse or used for purposes other than intended.

There are no warranties, express or implied, including without limitation any implied warranty of merchantability or fitness, which extend beyond the description of the face there of. If the product does not perform as warranted herein, purchaser's sole remedy shall be repair or replacement, at the option of Ludlum Measurements. In no event will Ludlum Measurements be liable for damages, lost revenue, lost wages, or any other incidental or consequential damages, arising from the purchase, use, or inability to use product.

## **RETURN OF GOODS TO MANUFACTURER**

If equipment needs to be returned to Ludlum Measurements, Inc. for repair or calibration, please send to the address below. All shipments should include documentation containing return shipping address, customer name, telephone number, description of service requested, and all other necessary information. Your cooperation will expedite the return of your equipment.

**LUDLUM MEASUREMENTS, INC.  
ATTN: REPAIR DEPARTMENT  
501 OAK STREET  
SWEETWATER, TX 79556**

**800-622-0828 325-235-5494  
FAX 325-235-4672**

REV #	ALTERATIONS	DATE	BY
1	VALID	02/19/04	CLW
2	ADDED DO NOT DISCARD SYMBOL	8/10/06	CMC
3	REMOVED CAL HOLE	10/17/06	CMC

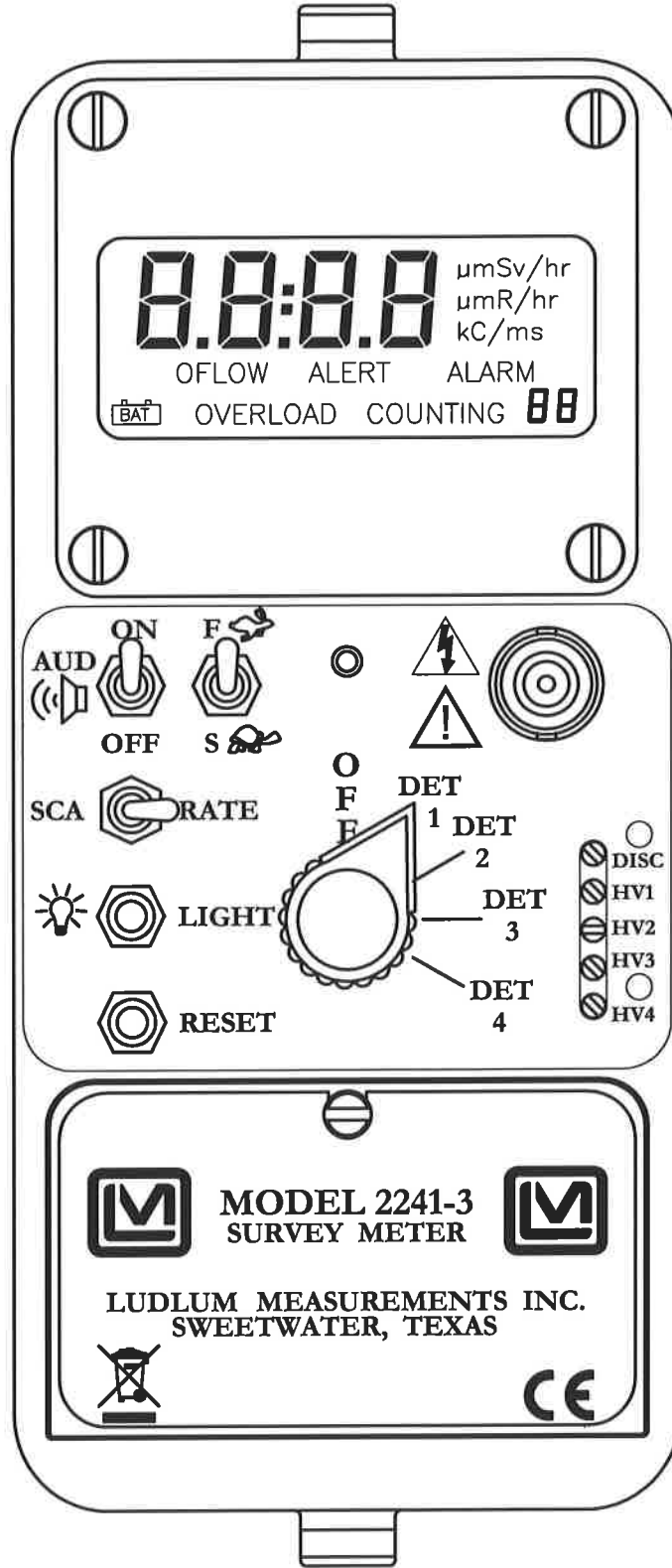

CHG	NO.	DVN	CHK	APP
DVN	DATE	CHK	DATE	APP
CMC	10/17/06			No U DATE 10-17-06
TOL: SHOP STD <input type="checkbox"/>		SCALE: FULL <input type="checkbox"/>		
OTHER		OTHER		
TITLE MODEL 2241-3				
LUDLUM MEASUREMENTS, INC. 500 DAK STREET SWEETWATER, TEXAS 79556		SERIES	SHEET	
		408	84	



# Table of Contents

---

<b><i>Introduction</i></b>	<b>1</b>
<b>The Instrument</b>	<b>1-1</b>
<b>The Detectors</b>	<b>1-2</b>
<b><i>Getting Started</i></b>	<b>2</b>
<b>Unpacking and Repacking</b>	<b>2-1</b>
<b>Battery Installation</b>	<b>2-1</b>
<b>Operational Check</b>	<b>2-2</b>
<b>Survey Techniques</b>	<b>2-4</b>
<b><i>Specifications</i></b>	<b>3</b>
<b>Instrument</b>	<b>3-1</b>
<b>Removable Switch Board Adjust Parameters</b>	<b>3-2</b>
<b>Model 44-9 Detector</b>	<b>3-3</b>
<b>Model 44-2 Detector</b>	<b>3-4</b>
<b>Model 133-7</b>	<b>3-4</b>
<b><i>Identification of Controls and Functions</i></b>	<b>4</b>
<b>Display</b>	<b>4-1</b>
<b>Display Status Definitions</b>	<b>4-1</b>
<b>Front Panel Controls</b>	<b>4-2</b>
<b>Front Panel Calibration Controls</b>	<b>4-3</b>
<b>Main Board Controls</b>	<b>4-4</b>
<b>Switch Board Controls</b>	<b>4-5</b>
<b><i>Safety &amp; Maintenance Considerations</i></b>	<b>5</b>
<b>Environmental Conditions for Normal Use</b>	<b>5-1</b>
<b>Detector Connector</b>	<b>5-1</b>
<b>Warning Markings and Symbols</b>	<b>5-1</b>
<b>Maintenance</b>	<b>5-2</b>
<b>Operational Check</b>	<b>5-3</b>
<b>Recalibration</b>	<b>5-3</b>
<b>Batteries</b>	<b>5-4</b>
<b>Detector Model 44-9 Tube Replacement Procedure</b>	<b>5-4</b>
<b><i>Radiation Basics</i></b>	<b>6</b>
<b>Radiation and Life</b>	<b>6-1</b>

<b>The Unstable Atom</b>	<b>6-2</b>
<b>Radioactive Decay</b>	<b>6-3</b>
<b>Ionizing Radiation</b>	<b>6-4</b>
<b>Measuring Ionizing Radiation</b>	<b>6-5</b>
<b>What are the Health Risks from Ionizing Radiation?</b>	<b>6-6</b>
<b>How Much Ionizing Radiation is Dangerous?</b>	<b>6-7</b>
<b>Background Radiation</b>	<b>6-10</b>
<b>Manmade Radiation</b>	<b>6-11</b>
<b>Protection from Radiation</b>	<b>6-11</b>
<b>Standards and Regulation</b>	<b>6-12</b>
<b>Who is in Charge?</b>	<b>6-12</b>
<b><i>Technical Principle of Operation</i></b>	<b><i>7</i></b>
<b>Main Board</b>	<b>7-1</b>
<b>Switch Board</b>	<b>7-3</b>
<b>Display Board</b>	<b>7-3</b>
<b><i>Instrument Setup and Calibration</i></b>	<b><i>8</i></b>
<b>Factory Settings</b>	<b>8-1</b>
<b>Entering or Changing Switch Board Parameters</b>	<b>8-1</b>
<b>The Function Switch</b>	<b>8-2</b>
<b>Function Switch Position Descriptions and Variables</b>	<b>8-2</b>
<b>Calibration</b>	<b>8-7</b>
<b>General Detector Setup Information</b>	<b>8-8</b>
<b>Counts per minute (C/m) Calibration</b>	<b>8-9</b>
<b>R/hr Calibration</b>	<b>8-11</b>
<b>Determining CC and DTC</b>	<b>8-12</b>
<b>Loading Default Parameters</b>	<b>8-19</b>
<b>Software License Agreement</b>	<b>8-20</b>
<b><i>Recycling</i></b>	<b><i>9</i></b>
<b><i>Parts List</i></b>	<b><i>10</i></b>
<b>Model 2241-3 Survey Meter</b>	<b>10-1</b>
<b>Main Circuit Board, Drawing 408 × 226</b>	<b>10-1</b>
<b>Calibration Board, Drawing 408 × 98</b>	<b>10-3</b>
<b>Display Board, Drawing 408 × 259</b>	<b>10-4</b>
<b>Switch Board, Drawing 408 × 45</b>	<b>10-5</b>

<b>Chassis Wiring Diagram, Drawing 408 × 101</b>	<b>10-5</b>
<b>Model 44-9 Alpha-Beta-Gamma Detector (Pancake)</b>	<b>10-6</b>
<b>Model 44-2 Gamma Scintillator</b>	<b>10-7</b>
<b>Model 133-7 G-M Detector</b>	<b>10-7</b>
<b><i>Drawings</i></b>	<b><i>11</i></b>
<b><i>RS-232 Outputs</i></b>	<b><i>A</i></b>
<b>Binary Output Format (15 Bytes)</b>	<b>A-1</b>
<b>ASCII Output Format</b>	<b>A-4</b>

**Section**  
**1**

## Introduction

---

The Model 2241-3RK is a first-responder kit that includes a portable microprocessor-based digital Scaler/ Ratemeter, as well as scintillation and Geiger-Mueller (GM) type detectors designed for the rugged use of first responders in the measuring of ionizing radiation. A rugged, waterproof, airtight carrying case with foam insert, check source with holder, and detector cable are provided.

### The Instrument

Data is presented on a four-digit (six digits in the Scaler mode) Liquid Crystal Display (LCD) with moving decimal point. A toggle switch labeled "SCA/RATE" selects the desired operating mode for the instrument. A five-position switch labeled "OFF/DET 1/DET 2/DET 3/DET 4" allows for a quick change of operating parameters when changing out detectors.

Programmable display units (RATEMETER mode only) can be represented in R/hr, Sv/h, cpm, or cps with multipliers of micro ( $\mu$ ) or milli (m) for R/hr and Sv/h and kilo (k) for cpm or cps. The display units are auto-ranging, enabling the readout to display a broad range of radiation levels. The display also offers lower limit capability. For example, the display can be set to show only values that are greater than or equal to  $1 \mu\text{R/hr}$ .

This instrument incorporates independent adjustable alarms for RATEMETER and SCALER operating modes. The RATEMETER mode has two alarm indicators. The first-level alarm is indicated by display of the word "ALERT" on the LCD. The second-level alarm is indicated by display of the word "ALARM" and by the emitting of a continuous audible tone. The SCALER alarm condition will also display the word "ALARM" and produce the same audible tone. Both audible alarms may be silenced (acknowledged) by depressing the RESET switch. All alarms are concurrent.



Other features include: 1) Dead Time Correction (DTC) to compensate for detector dead time, 2) audible click-per-event with programmable 1, 10, 100, and 1000 divide-by; 3) LCD backlight with programmable ON time, 4) programmable fixed or variable response time, and 5) count overflow visual alarm, indicating that the counting circuitry is nearing the maximum counting capability.

All of the features described above may be programmed manually using the internal switch board or by computer through the RS-232 port. Four different detector operating parameters may be stored in non-volatile memory. The switch board can be removed after entering or changing parameters to prevent tampering with setup parameters.

A regulated high-voltage power supply, four independent set-point controls adjustable from 400 to 2500 volts, and adjustable discrimination levels add versatility to the instrument. This supports operation for a broad range of detectors and connecting cable lengths. All of the calibration controls are covered to prevent any inadvertent adjustment to the detector operating parameters.

The instrument is powered by two standard "D" cell batteries. The unit body is made of cast-and-drawn aluminum with beige powder coating, which aids in the decontamination of surfaces.

## The Detectors

The Response Kit's G M (Geiger-Mueller) Pancake Detector, Model 44-9, will detect alpha, beta, and gamma radiation. Its size and shape provide easy handling for surveying or personnel monitoring. The detector is energy dependent, over-responding by a factor of 6 (to gamma radiation) in the 60 keV–100 keV range when normalized to  $^{137}\text{Cs}$ . The response of this detector is nominally linear (within 10%) from 1 mR/hr to 300 mR/hr.



The Model 44-9 operates at 900 volts. The recommended instrument input sensitivity (set at calibration) is approximately  $30 \pm 10$  mV to prevent the detector from double pulsing.

The thin mica window in this detector is protected by a 79% open stainless steel screen. The GM tube can be easily removed for replacement if necessary. The GM tube face may rupture above 8000 feet altitude pressure. Consequently, tube failure is likely if transported above this altitude in an aircraft not pressurized.

The Response Kit's sodium iodide (NaI) gamma scintillator, Model 44-2, is used for the detection of low-level gamma radiation, in the range of 60 keV–1.25 MeV. The detector is energy dependent, over-responding by a factor of 10 or greater in the 100 keV range, and under-responding by a factor of 0.5 above 1 MeV when normalized to  $^{137}\text{Cs}$ . The response of this detector is nominally linear (within 10%), from 5  $\mu\text{R/hr}$  to 50 mR/hr.



This detector consists of a 2.5 x 2.5 cm (1 x 1 in.) (Dia x thickness), NaI crystal, coupled to a photomultiplier tube, and is housed in 0.16 cm (0.06 in.) thick aluminum housing. Recommended instrument sensitivity is approximately 10mV or higher. Operating voltage varies from one detector to another.

Common applications for this detector include background radiation monitoring and low-level radiation detection.

The Response Kit's GM gamma survey detector, Model 133-7, is primarily used for the detection of high-level gamma radiation. The response of this detector is nominally linear (within 10%), from 25 mR/hr to 100 R/hr. Dead-time (set at calibration) is typically 50 microseconds. This detector operates at 460 volts with a recommended instrument input sensitivity of  $30 \pm 10$  mV (set at calibration).

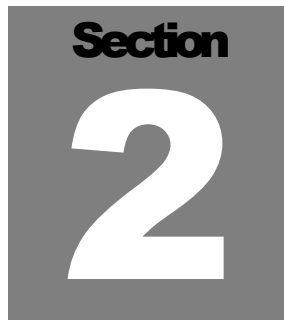

A dark gray square containing the word "Section" in a bold, black, sans-serif font at the top, and a large, white, bold number "2" in the center.

## Getting Started

---

### Unpacking and Repacking

Remove the calibration certificates and place them in a secure location. Remove the instrument, detectors and accessories (batteries, cable, etc.), and ensure that all of the items listed on the packing list are in the carton. Check individual item serial numbers and ensure calibration certificates match. The Model 2241-3 serial number is located on the front panel below the battery compartment. Most Ludlum Measurements, Inc. detectors have a label on the base or body of the detector for model and serial number identification.

#### **Important!**

If multiple shipments are received, ensure that the detectors and instruments are not interchanged. Each instrument is calibrated to specific detectors, and are therefore, not interchangeable.

To return an instrument for repair or calibration, provide sufficient packing material to prevent damage during shipment. Also provide appropriate warning labels to ensure careful handling. Include detector(s) and related cable(s) for calibration

Every returned instrument must be accompanied by an **Instrument Return Form**, which can be downloaded from the Ludlum website at [www.ludlums.com](http://www.ludlums.com). Find the form by clicking the “Support” tab and selecting “Repair and Calibration” from the drop-down menu. Then choose the appropriate Repair and Calibration division where you will find a link to the form.

### Battery Installation

Ensure the OFF/DET 1/DET 2/DET 3/DET 4 switch is in the OFF position. Open the battery lid by turning the quarter-turn thumb screw counter-

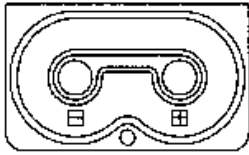

clockwise. Install two “D” size batteries in the compartment. Note the (+) and (–) marks inside the battery door. Match the battery polarity to these marks. Close the battery box lid.

**Note:**

The center post of a “D” size battery is positive.

### Operational Check

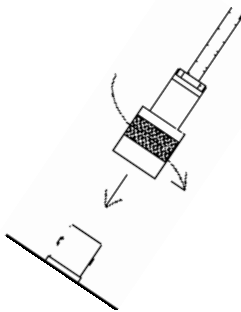

Connect a detector to the Model 2241-3 by using the cable provided; firmly pushing the connectors together while twisting clockwise until the connector latches (one-quarter turn). The diagram to the left illustrates how this is done. Next, place the detector selector switch in the appropriate position.

**Note:**

The Model 2241-3 front panel (when part of a response kit) includes a color code at the detector selector switch, which corresponds to color-coded detectors, included in the kit. This serves as a reminder (quick reference) of the set detector parameters for each position. See Section 8, Subsection “Factory Settings,” (Page 8-1) for the color code.

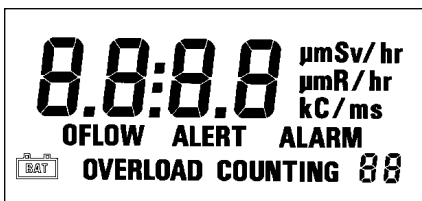

Place the SCA/RATE (scaler/ratemeter) switch in the RATE position. Notice that the display goes through an initialization sequence. The display will show all “8”s with decimal points. Check to make sure all segments display, as illustrated in the diagram to the left.

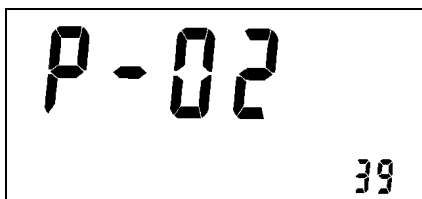

The LCD then displays the firmware number in the format “P-XX YY.” The “XX” is the firmware number, and the “YY” is the firmware version. (The figure to the left is for example only; to illustrate location of display.)

The minimum displayable value (for example 00.0 μR/hr) should be shown. When switched to the SCA position, a single 0 will be displayed.





The display will auto-range to the current level (see figure at left). When auto-ranging down, the Model 2241-3 uses multiples of 5. This technique keeps the decimal point from jumping between numbers when viewing values around multiples of 10.

Check for a proper background reading:

If using a Ludlum Model 44-9 detector, a typical reading would be 25-50 cpm or 8-15 uR/hr.

If using a Ludlum Model 44-2 detector, a typical reading would be 1.4-2.6 kcpm or 8-15 uR/hr.

If using a Ludlum Model 133-7 detector, a typical reading would be 0 cpm or 8-15 uR/hr.

A reference reading (or readings) with a check source should be obtained with the detector(s) in a constant and reproducible manner at the time of calibration or at the time the instrument is received in the field.

If at any time the instrument fails to read within 20% of the reference reading when using the same check source, it should be sent to a calibration facility for recalibration and/or repair. If desired, multiple readings may be taken at different distances and/or with different sources so that other ranges or scales are checked.

Switch the AUD ON/OFF switch to the ON position and confirm that the external unimorph speaker produces an audible click for each event detected (audio divide-by 1 parameter). The AUD ON/OFF switch will silence the clicks if in the OFF position; however, an audible alarm condition will still be heard.

Increase the source activity or lower the alert and alarm points to initiate an ALERT and ALARM condition. (Refer to Section 8, Subsection “Entering or Changing Switchboard Parameters.”) Depress the RESET switch to acknowledge the audible alarm. Decrease the radiation activity below the ALERT and ALARM threshold and depress the RESET switch to clear the alarm conditions. If an alarm condition is not present, depressing the RESET switch the first time will reset the alert condition and zero the ratemeter.

Position a check source to produce a ratemeter reading of 100 to 2000 counts/minute or 10-100 μR/hr. While observing the ratemeter fluctuations, select between the fast and slow response time (F/S) positions to observe

variations in the display. The S position should respond approximately five times slower than the F position (for fixed response mode) and three times slower when in variable response mode. The slow response position is normally used when the Model 2241-3 is displaying low numbers which require a more stable display. The fast response position is used at high count levels.

Place the SCA/RATE switch to the SCA position. Depress the COUNT switch located in the end of the carrying handle in order to initiate a count cycle. The word "COUNTING" should be flashing on the LCD during the count cycle and should disappear at the end of the predetermined count time. If a scaler ALARM condition occurs, the RESET switch can be depressed to acknowledge the alarm; however, the COUNT switch must be depressed to clear the visual ALARM and to restart the count cycle.

Depress and release the LIGHT switch. The backlight located behind the LCD should illuminate (for pre-programmed ON time). Select the desired F/S, AUD ON/OFF, and RATE/SCA parameters and proceed to use the instrument.

## Survey Techniques

**Alpha:** When using the Ludlum Model 2241-3 Response Kit, the pancake detector (Model 44-9) must be used for detection of alpha.

Keep in mind that moisture or dirt may block alpha particles, making them impossible to be measured.

All shielding material must be removed from the suspected source.

Ensure that the instrument F/S switch is in the F position.

When surveying for alpha, it is very important to get the window of the detector within three-quarters inch of the surface to be surveyed.

Move the detector over the area to be measured as slowly as possible (typically one to two inches per second) keeping in mind that the instrument response time varies from 2 to 50 seconds.

**Beta:** To detect beta, the pancake detector (Model 44-9) must be used.

Move the detector over the area to be measured as slowly as possible (the instrument response time varies from 2 to 50 seconds).

Shielding may be utilized to determine the type of source (alpha or beta). Take a measurement with no shielding in place, then another with a piece of paper or other thin material placed over the suspected source.

Compare the first reading with the second to determine the amount of alpha and beta contribution (This will be a very rough number).

**Gamma and X-ray:** For gamma and high-energy X-ray, the gamma scintillator (Model 44-2), or the GM high-range gamma detector (Model 133-7) must be used.

**The Model 44-2** is approximately 50 times more sensitive than the pancake (Model 44-9) detector. This detector is able to detect low level gamma and X-rays in the range of 60 keV–1.25 MeV. This detector may be used for measurements up to 50 mR/hr.

**The Model 133-7** is used for high-range gamma measurements of 25 mR/hr–100 R/hr. Instrument readout is in R/hr.

Both Model 44-2 and 133-7 are used by placing the detector in hand, and by slowly moving it from side to side over the area to be measured.

Be aware that the very end of the detector, opposite the connector, is the most sensitive. Therefore, point the detector towards the radiation being measured.

Section  
**3**

**Instrument**

## Specifications

**Linearity:** Readings are within 10% of true value with a detector connected.

**Warm-up Time:** Unit may be used immediately after the LCD initialization sequence is completed (approximately 5 seconds after power-up).

**Display:** a four-digit Liquid Crystal Display (LCD) with digits 1.3 cm (0.5 in.) in height. Two additional 0.5 cm (0.2 in.) digits are used for the overflow counter (SCALER mode) and exponential powers (parameter setup). Enunciators are provided for display units, ALERT, ALARM, low battery, detector OVERLOAD (not used), counting OVERFLOW, and scaler COUNTING.

**RATEMETER:** Depending upon how the instrument was calibrated, the RATEMETER can display in either R/hr, Sv/h, cpm, or cps when the control switch is in the RATEMETER position.

**SCALER:** activated by pushbutton in handle when the three-position switch is in the SCALER position. Count time is adjustable.

**Calibration Controls:** accessible from the front of the instrument (protective cover provided). These controls are preset at the factory or calibration lab and should not be adjusted by field personnel.

**Discriminator / Input Sensitivity:** adjustable from 2 to 100 mV; negative pulse response

**High Voltage:** four independent controls, each adjustable from 400-2500 volts; four separate set points for each detector setup- HV 1, HV 2, HV 3, and HV 4, regulated within 0.2% at 1000 Vdc; maximum load of 50  $\mu$ A

**RESET:** a pushbutton for zeroing the display, acknowledging and/or resetting the alarm

**Note:**

The RESET button only silences the alarm in the current mode that the instrument is in. For example, the RESET button will not affect the **scaler** alarm if the instrument is in the **ratemeter** mode.

**LIGHT:** display backlight activated by pushbutton

**Audio:** built-in audio speaker (unimorph) with AUD ON/OFF switch; at maximum volume > 60 dB at 0.61 m (2 ft); internal adjustable volume

**Alert/Alarm:** indicated by either an ALERT or ALARM enunciator on the display (RATEMETER mode only) and by an audible tone

**Power:** two each "D" cell batteries housed in an externally accessible sealed compartment. Current draw is approximately 35 mA with the backlight OFF. Minimum battery voltage is  $2.2 \pm 0.1$  Vdc.

**Battery Dependence:** Meter readings vary by less than 3% from fully charged batteries until the battery symbol appears, indicating the need for recharge or replacement.

**Battery Life:** typically 200 hours with alkaline batteries (display indicates low-battery condition). Instrument will operate for approximately 24 hours after the battery symbol first appears.

**Size:** 16.5 x 8.9 x 21.6 cm (6.5 x 3.5 x 8.5 in.) (H x W x D)

**Weight:** 1.6 kg (3.5 lb), including batteries

**Removable  
Switchboard  
Adjustable  
Parameters**

**Backlight "ON" Time:** 5, 15, 30, 60, 90, 120, 180, or 240 seconds for the backlight to stay on when activated by the pushbutton; factory set at 5

**Set Minimum Display:** allows lower limit of the auto-ranging display to be fixed. For example, the display can be set to only show values above or equal to 1  $\mu$ R/hr.

**RS-232 Data Dump Mode:** enables or disables dump mode to the RS-232 port ("D" type connector). When enabled, the data will be dumped every two seconds.

**RS-232 Detector Setup Mode:** allows for input of detector parameters via the RS-232 port

**Baud Rate:** selects either 150, 300, 600, 1200, 2400, 4800, 9600, or 19200 bps

**Detector Dead Time Compensation (DTC):** adjustable from 0 to 9999 microseconds

**Calibration Constant:** adjustable from 0.001 to  $280 \times 10^9$  counts/display unit

**Display Units:** can display in R/hr, Sv/h, cpm, or cps

**Time Base:** can display in seconds or minutes

**Audio Divide:** 1, 10, 100, or 1000 events per click

**Response Time:** variable or fixed ratemeter response (All stated times correspond to a range of 10% to 90% of the final reading). Factory default is "variable" so that the instrument will automatically adjust the response time to the best setting for the current count rate.

**Variable Response:** dependant on the number of counts present, typically 4 to 25 seconds for FAST, and 4 to 60 seconds for SLOW

**Fixed Response:** The parameter is adjustable from 1-25 seconds, resulting in a FAST response from approximately 2-50 seconds. The SLOW response is approximately 10-250 seconds. For MDA-type measurements, the fixed response mode is recommended.

**Ratemeter Alert/Alarm:** set at any point corresponding to the pre-selected ratemeter range

**Scaler Alarm:** adjustable from 1 to 999999 counts

**Scaler Count Time:** adjustable from 1 to 9999 seconds

**Model 44-9  
Detector**

**Indicated Use:** survey low levels of mid to high-energy gammas

**Detector:** pancake-type halogen quenched Geiger-Muller (GM)

**Window:**  $1.7 \pm 0.3$  mg/cm<sup>2</sup> mica

**Window Area:** Active is 15 cm<sup>2</sup>. Open is 12 cm<sup>2</sup>.

**Efficiency** ( $4\pi$  geometry): typically 5% for <sup>14</sup>C, 22% for <sup>90</sup>Sr/<sup>90</sup>Y, 19% for <sup>99</sup>Tc, 32% for <sup>32</sup>P, and 15% for <sup>239</sup>Pu.

**Sensitivity:** typically 3300 cpm per mR/hr (<sup>137</sup>Cs gamma)

**Energy Response:** energy dependent

**Dead Time:** typically 80 microseconds

**Operating Voltage:** 900 volts

**Construction:** aluminum housing with beige powder-coat paint

**Size:** 4.6 x 6.9 x 27.2 cm (1.8 x 2.7 x 10.7 in.) (H x W x D)

**Weight:** 0.5 kg (1 lb)

**Model 44-2  
Detector****Indicated Use:** low level gamma detection**Scintillator:** 2.5 cm diameter x 2.5 cm thick (1 x 1 in.); sodium iodide (NaI) T1 scintillator.**Sensitivity:** typically 175 cpm per  $\mu\text{R/hr}$  ( $^{137}\text{Cs}$ )**Tube:** 2.9 cm (1.1 in.) diameter; magnetically shielded photomultiplier**Operating Voltage:** typically 500 to 1200 volts**Dynode String Resistance:** 100 megohm**Construction:** aluminum housing with beige powder-coat paint**Size:** 5.1 x 18.5 cm (2 x 7.3 in.) (Dia x L)**Weight:** 0.5 kg (1 lb)**Model 133-7****Indicated Use:** high-range gamma measurements**Detector:** halogen quenched GM (energy compensated)**Dead Time:** typically 50 microseconds**Linear Range with Dead Time Correction:** 25 mR/hr – 100 R/hr**Linear Range without Dead Time Correction:** 25 mR/hr – 30 R/hr**Sensitivity:** 4.2 cpm per mR/hr ( $^{60}\text{Co}$  gamma)**Energy Response:** within 15% of true value**Construction:** anodized aluminum housing**Size:** 2.5 x 10.2 cm (1 x 4 in.) (Dia x L)**Weight:** 0.09 kg (0.2 lb)

## Section

## 4

## Identification of Controls and Functions

### Display

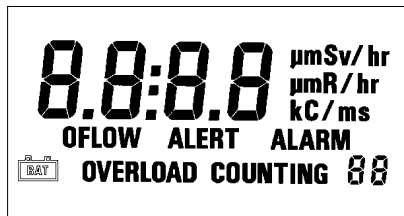

The Model 2241-3 utilizes a four-digit liquid crystal display (LCD) with a two-digit overflow (SCALER mode) and moving decimal point. The two smaller digits located in the lower right corner of the display indicate counter OVERFLOW when in the scaler counting mode (equivalent to a six-digit scaler) or exponential power when in the parameter setup mode. The upper right corner of the LCD displays units and multiplier(s): R/hr, mR/hr, or  $\mu$ R/hr; Sv/h, mSv/h or  $\mu$ Sv/h; C/m, kC/m, C/s or kC/s. The bottom part of the readout displays the ALARM, ALERT, OFLOW, OVERLOAD (not used) enunciators, and the low-battery icon. COUNTING indicates that the scaler mode has been initiated and is in the counting process.

### Display Status Definitions

**ALARM:** Ratemeter or scaler count has increased above the preset alarm threshold. An audible continuous tone will accompany the latching ALARM condition. Depressing RESET will acknowledge the audible ratemeter and/or scaler alarm. Depressing RESET a second time will reset the ratemeter reading and ratemeter alarm. To reset the scaler ALARM, depress the COUNT switch located in the carrying handle to re-initiate the scaler count cycle.

**ALERT:** Ratemeter count has increased above the preset alert threshold. To reset an ALERT condition, press RESET once if in the non-alarm condition and twice if in an alarm condition. (The first depression in the alarm condition acknowledges the audible alarm.) The ratemeter will reset to the minimum displayable reading each time the alert is reset.

**OFLOW (Overflow)** [RATEMETER mode]: indicates that the incoming count exceeds the capability to display stable or reliable readings corresponding to the radiation level being measured. The overflow symbol will appear when the ratemeter exceeds 100 kcps or if the dead time correction is greater than 75%. OFLOW will appear in the SCALER



mode when the six-digit display (four digits display and two overflow digits in right corner) reaches "999999" and starts to roll over again.

**Low battery icon:** indicates that the batteries have decreased to the minimum operating voltage of  $2.2 \pm 0.1$  Vdc. Instrument will continue to operate for approximately 24 hours thereafter.

**COUNTING:** indicates that the scaler COUNT switch has been depressed and that the scaler is accumulating counts for the pre-determined count time

## Front Panel Controls

**OFF/DET 1/DET 2/DET 3/DET 4 Switch:** a five-position rotary switch that applies power to the instrument and selects the desired set of detector parameters

**SCA/RATE (Mode) Switch:** a protected (locking) toggle switch that toggles between ratemeter or scaler counting modes. The user pulls up and then over to change modes

**AUD ON/OFF Switch:** The click-per-event audio may be silenced or enabled via this front-panel toggle switch. The audible alarm is independent of the AUD ON/OFF switch and will override the audible click-per-event. An audible alarm can only be silenced by depressing the RESET button.

**F/S (Fast/Slow) Response Switch:** a two-position toggle switch that selects fast or slow counting response time

**Variable Response:** The F position allows the time constant (TC) to vary from 1 to 10 seconds, while the S position varies from 1 to 30 seconds. The response time is automatically adjusted in proportion to the incoming count rate between the F/S TC variables.

**Fixed Response:** The F position corresponds to the selected fixed response time - TC. The S position is five times slower than the selected fast TC.

**LIGHT (LCD Backlight):** A pushbutton switch, when depressed, illuminates the LCD for a pre-programmed time. The backlight ON time can be selected between 5 and 240 seconds during the parameter setup.

**RESET Pushbutton:** In the non-alarm condition, depressing the RESET switch resets the ratemeter display to the minimum display readout. In an alarm condition (ratemeter or scaler), depressing RESET will silence the audible alarm. Depressing RESET a second time will reset the ratemeter alarm and/or alert condition. The scaler alarm can only be reset by depressing the scaler count switch located in the end of the Model 2241-3 handle.

**Note:**

The RESET button only silences the alarm in the current mode that the instrument is in. For example, the RESET button will not affect the **scaler** alarm if the instrument is in the **ratemeter** mode.

**Scaler Count Switch:** pushbutton switch located in the end of the Model 2241-3 carrying handle, which when depressed, initializes the start of the scaler count accumulation for the preset scaling time. The SCA/RATE switch must be in the SCA position to initiate the counting cycle. The scaler display uses the two digits in the lower right hand corner for the two most significant digits of the six-digit readout. Scaling time can be set from 1 to 9999 seconds in the parameter setup by way of the switch board. Depressing the Count switch after a scaler ALARM will reset the scaler display to 0, resetting the alarm condition.

## Front Panel Calibration Controls

**Note:**

Remove the front-panel calibration cover to expose the following calibration controls:

**DISC** (Discriminator): A multi-turn potentiometer (approximately 20 revolutions) is used to vary the detector pulse-counting threshold from 2 to 100 millivolts. A Ludlum Model 500 Pulser or equivalent should be used in checking or adjusting the pulse discrimination parameter.

**Note:**

When making adjustments to the HV potentiometers, make note of the following precautions: Use a Ludlum Model 500 pulser or high-impedance voltmeter with a high-voltage probe to measure the high voltage at the detector connector. If a Ludlum Model 500 Pulser is not available, ensure that the impedance of voltmeter used is 1000 megohms or greater.

**HV1, HV2, HV3, HV4:** Multi-turn potentiometers (approximately 20 revolutions) that vary the detector voltage from 200 to 2500 volts. The maximum high-voltage output is adjusted by the HV LIMIT potentiometer located on the internal main board.

## Main Board Controls

**Note:**

To access the internal circuit boards, unlatch the latches at each end of the Model 2241-3. Carefully separate the top chassis from the bottom cover (referred to as a can). The can has the audio speaker (unimorph) with a two-conductor cable attached to the main board. The audio plug may be disconnected during the internal control adjustments.

**HV LIMIT (R027):** A multi-turn potentiometer (approximately 20 revolutions) sets the maximum HV limit with the front-panel HV control adjusted to the maximum clockwise position. It is adjustable from 1250 to 2500 Vdc.

**VOLUME (R002):** A multi-turn potentiometer (approximately 20 revolutions) varies the audible click-per-event and alarm audio. Adjust the control to the maximum clockwise position for maximum volume. If the VOLUME control is adjusted to the maximum counterclockwise position, the clicks-per-event or the audible alarm(s) will not be audible when active.

## Switch Board Controls

The switch board utilizes a 16-position rotary switch (FUNCTION) to select the 16 setup parameters. (Refer to schematics and component layout drawing near the end of the manual.) All of the setup parameters are stored in the non-volatile EEPROM, which will retain data even after the Model 2241-3 batteries are removed. After the parameters are entered, the switch board can be removed, and the Model 2241-3 will continue to operate from the previously programmed information. Changing parameters and information on switchboard controls are covered in detail in Section 8 of this manual.

**Section****5**

## **Safety & Maintenance Considerations**

---

### **Environmental Conditions for Normal Use**

Indoor or outdoor use

Maximum altitude of 2438 m (8000 ft) above sea level

Temperature range of -20 to 50 °C (-4 to 122 °F)

Maximum relative humidity of less than 95% (non-condensing)

Pollution Degree 3 (as defined by IEC 664). (Occurs when conductive pollution or dry nonconductive pollution becomes conductive due to condensation. This is typical of industrial or construction sites.)

### **Detector Connector**

**Caution!**

The detector operating voltage (HV) is supplied to the detector by way of the input connector. A mild electric shock may occur if contact is made with the center pin of the input connector. Switch the Model 2241-3 to the OFF position before connecting or disconnecting the cable or detector.

### **Warning Markings and Symbols**

**Caution!**

The operator or responsible body is cautioned that the protection provided by the equipment may be impaired if the equipment is used in a manner not specified by Ludlum Measurements, Inc.

**Caution!**

Verify instrument voltage input rating before connecting to a power converter. If the wrong power converter is used, the instrument and/or power converter could be damaged.

The Model 2241-3 Survey Meter is marked with the following symbols:



**CAUTION, RISK OF ELECTRIC SHOCK** (per ISO 3864, No. B.3.6): designates a terminal (connector) that allows connection to a voltage exceeding 1 kV. Contact with the subject connector while the instrument is on or shortly after turning off may result in electric shock. This symbol appears on the front panel.



**CAUTION** (per ISO 3864, No. B.3.1): designates hazardous live voltage and risk of electric shock. During normal use, internal components are hazardous live. This instrument must be isolated or disconnected from the hazardous live voltage before accessing the internal components. This symbol appears on the front panel. **Note the following precautions:**

**Warning!**

The operator is strongly advised to take the following precautions to avoid contact with internal hazardous live parts that are accessible using a tool:

1. Turn the instrument power OFF and remove the batteries.
2. Allow the instrument to sit for one minute before accessing any internal components.



The “**crossed-out wheelie bin**” symbol notifies the consumer that the product is not to be mixed with unsorted municipal waste when discarding. Each material must be separated. The symbol is placed on the battery compartment. See Section 9, “Recycling,” for further information.



The “CE” mark is used to identify this instrument and detectors as being acceptable for use within the European Union.

## Maintenance

Instrument maintenance consists of keeping the instrument clean and periodically checking the batteries and the calibration. The Model 2241-3 instrument may be externally cleaned with a damp cloth (using only water as the wetting agent). Do not immerse the instrument in any liquid. Observe the following precautions when cleaning:

1. Turn the instrument OFF and remove the batteries.
2. Allow the instrument to sit for one minute before performing any external cleaning or accessing internal components for maintenance.

### OPERATIONAL CHECK

An instrument operational check should be performed prior to each use by exposing the detector to the supplied check source, confirming the proper reading on each scale. See Section 2, Subsection “Operational Check,” for further details.

### RECALIBRATION

Recalibration should be accomplished after any maintenance or adjustment of any kind has been performed on the instrument. Battery and cable replacements (of same length) and exterior cleanings do not normally require the instrument be recalibrated.

**Note:**

Ludlum Measurements, Inc. recommends recalibration at intervals no greater than one year. Check the appropriate local, state, and federal regulations to determine required recalibration intervals.

Ludlum Measurements offers a full-service repair and calibration department. We not only repair and calibrate our own instruments but most other manufacturers’ instruments as well.

See Section 8, “Instrument Setup & Calibration,” for further details on instrument calibration.

**BATTERIES**

The batteries should be removed, and the battery contacts cleaned of any corrosion at least every three months. If the instrument has been exposed to a very dusty or corrosive atmosphere, the battery should be served more frequently. Use a spanner wrench to unscrew the battery contact insulators, exposing the internal contacts and battery springs. Removing the handle will facilitate access to these contacts.

**Note:**

Never store the instrument over 30 days without removing the batteries. Although this instrument will operate at very high ambient temperatures, battery seal failure can occur at temperatures as low as 37 °C (100 °F).

**DETECTOR MODEL 44-9 TUBE REPLACEMENT PROCEDURE**

Consult the Model 44-9 Alpha-Beta-Gamma Detector drawing in Section 11 of this manual to perform the following:

**Caution!**

The mica window of this tube is *extremely thin* and can easily break. There is also a thin layer of material to prevent UV interference. This material may come off if touched, causing the detector to malfunction. **DO NOT TOUCH.**

1. Remove the back plate by removing the three screws.
2. Loosen the three set screws on the side of the tube housing.
3. Remove the old tube from the detector housing.
4. Remove the anode clip from the old tube.
5. Push the clip onto the anode housing.

**Note:**

Do not over-flex the wire when installing the clip!

6. Carefully install the tube with the window face down in the housing. Tighten the set screws evenly. The tube should be flush against the screen.
7. Replace the back plate and the retaining screws.
8. The detector is now ready for use.



**Note:**

The instrument and detector will need to be recalibrated once the above procedure is complete.

---

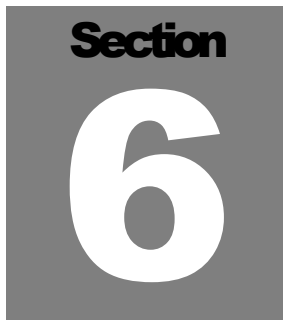
A dark gray square containing the word "Section" in a bold, black, sans-serif font at the top, and a large, white, bold, sans-serif number "6" in the center.

## Radiation Basics

---

### Radiation and Life

*Adapted from Eric J. Hall's book, "Radiation and Life"*

Radiation is energy traveling through space. Sunshine is one of the most familiar forms of radiation. It delivers light, heat, and vitamins. We control its effect on us with sunglasses, shade, air conditioners, hats, clothes, and sunscreen.

There would be no life on earth without lots of sunlight, but we have increasingly recognized that too much of it on our bodies is not a good thing. In fact, it may be dangerous, so we control our exposure to it.

Sunshine consists of radiation in a range of wavelengths from long-wave infrared to short-wavelength ultraviolet, which creates the hazard.

Beyond ultraviolet are higher energy kinds of radiation that are used in medicine, and which we all get in low doses from space, from the air, and from the earth. Collectively we can refer to these kinds of radiation as **ionizing radiation**. It can cause damage to matter, particularly living tissue. At high levels it is therefore dangerous, so it is necessary to control our exposure.

Background radiation is that which is naturally and inevitably present in our environment. Levels of this can vary greatly. People living in granite areas or on mineralized sands receive more terrestrial radiation than others, while people living or working at high altitudes receive more cosmic radiation. A lot of our natural exposure is due to radon, a gas which seeps from the earth's crust and is present in the air we breathe.

## The Unstable Atom

Radiation comes from atoms, the basic building blocks of matter.

Most atoms are stable; a  $^{12}\text{C}$  atom, for example, remains a  $^{12}\text{C}$  atom forever, and an  $^{16}\text{O}$  atom remains an  $^{16}\text{O}$  atom forever, but certain atoms eventually disintegrate into a totally new atom. These atoms are said to be unstable or radioactive. An unstable atom has excess internal energy, with the result that the nucleus can undergo a spontaneous change towards a more stable form. This is called radioactive decay.

When an atom of a radioisotope decays, it gives off some of its excess energy as radiation in the form of gamma rays or fast-moving sub-atomic particles. One can describe the emissions as gamma, beta, and alpha radiation.

Apart from the normal measures of mass and volume, the amount of radioactive material is given in **curie** (Ci), a measure which enables us to compare the typical radioactivity of some natural and other materials.

### Radioactivity of some natural and other materials

1 adult human ( $2.7 \times 10^{-9}$ Ci/kg)	$1.89 \times 10^{-7}$ Ci
1 kg (2.2 lb) of coffee	$2.70 \times 10^{-8}$ Ci
1 kg (2.2 lb) of super phosphate fertilizer	$1.35 \times 10^{-7}$ Ci
The air in a $100 \text{ m}^2$ ( $1076 \text{ ft}^2$ ) Australian home (radon)	$8.12 \times 10^{-8}$ Ci
The air in many $100 \text{ m}^2$ ( $1076 \text{ ft}^2$ ) European homes (radon)	$8.12 \times 10^{-7}$ Ci
1 household smoke detector (with americium)	$8.12 \times 10^{-7}$ Ci
Radioisotope for medical diagnosis	$1.89 \times 10^3$ Ci
Radioisotope source for medical therapy	2702.7 Ci
1 kg (2.2 lb) of 50-year old vitrified high-level nuclear waste	270.27 Ci
1 luminous Exit sign (1970s)	27.027 Ci
1 kg (2.2 lb) of uranium	$675.68 \times 10^6$ Ci
1 kg (2.2 lb) of uranium ore (Canadian, 15%)	$675.68 \times 10^6$ Ci

1 kg (2.2 lb) of uranium ore (Australian, 0.3%)	13.51 X 10 <sup>6</sup> Ci
1 kg (2.2 lb) of low-level radioactive waste	27.03 X 10 <sup>6</sup> Ci
1 kg (2.2 lb) of coal ash	5.41 X 10 <sup>-8</sup> Ci
1 kg (2.2 lb) of granite	2.70 X 10 <sup>-8</sup> Ci

NB. Though the intrinsic radioactivity is the same, the radiation dose received by someone handling a kilogram of high grade uranium ore will be much greater than for the same exposure to a kilogram of separated uranium, since the ore contains a number of short-lived decay products (see section on Radioactive Decay).

## Radioactive Decay

Atoms in a radioactive substance decay in a random fashion but at a characteristic rate. The length of time this takes, the number of steps required and the kinds of radiation released at each step are well known.

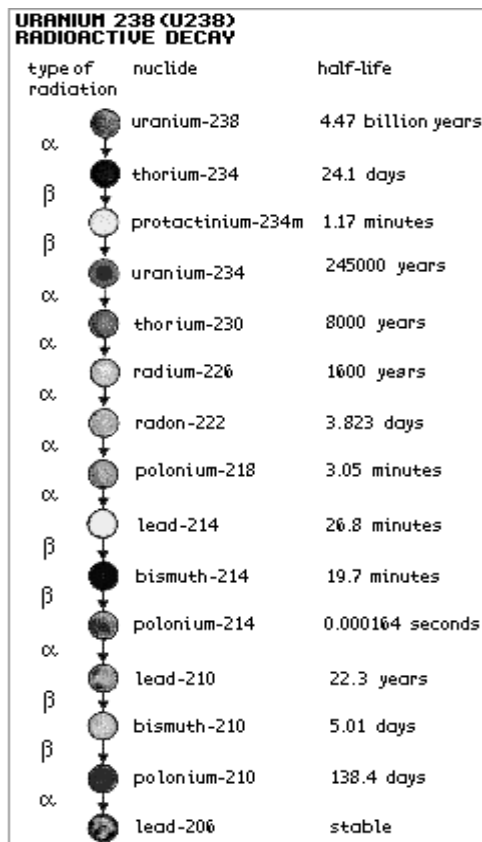

The half-life is the time taken for half of the atoms of a radioactive substance to decay. Half-lives can range from less than a millionth of a second to millions of years, depending upon the element concerned. After one half-life the level of radioactivity of a substance is halved, after two half-lives it is reduced to one quarter, after three half-lives to one-eighth and so on.

All uranium atoms are mildly radioactive. The following figure for uranium-238 shows the series of different radioisotopes it becomes as it decays, the type of radiation given off at each step and the 'half-life' of each step on the way to stable, non-radioactive lead-206.

The shorter-lived each kind of radioisotope, the more radiation it emits per unit mass. Much of the natural radioactivity in rocks and soil comes from this decay chain.

## Ionizing Radiation

Here we are concerned mainly with ionizing radiation from the atomic nucleus. It occurs in two forms – rays and particles – at the high frequency end of the energy spectrum.

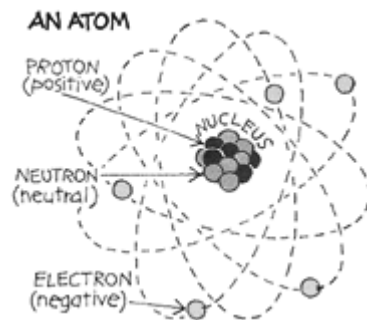

There are several types of ionizing radiation:

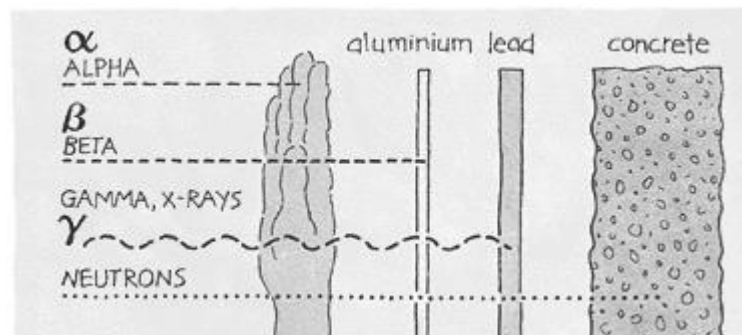

**X-rays and gamma rays**, like light, represent energy transmitted in a wave without the movement of material, just as heat and light from a fire or the sun travel through space. X-rays and gamma rays are virtually identical, except that X-rays are generally produced artificially rather than coming from the atomic nucleus. Unlike light, X-rays and gamma rays have great penetrating power and can pass through the human body. Thick barriers of concrete, lead, or water are used as protection from them.

**Alpha particles** consist of two protons and two neutrons, in the form of atomic nuclei. They thus have a positive electrical charge and are emitted from naturally occurring heavy elements such as uranium and radium, as well as from some man-made elements.

Because of their relatively large size, alpha particles collide readily with matter and lose their energy quickly. They therefore have little penetrating power and can be stopped by the first layer of skin or a sheet of paper.

However, if alpha sources are taken into the body, for example by breathing or swallowing radioactive dust, alpha particles can affect the body's cells. Inside the body, because they give up their energy over a relatively short distance, alpha particles can inflict more severe biological damage than other radiations.

**Beta particles** are fast-moving electrons ejected from the nuclei of atoms. These particles are much smaller than alpha particles and can penetrate up to 5/64 of an inch of water or human flesh. Beta particles are emitted from many radioactive elements. They can be stopped by a sheet of aluminum a few millimeters thick.

**Neutrons** are particles which are also very penetrating. On Earth they mostly come from the splitting, or fissioning, of certain atoms inside a nuclear reactor. Water and concrete are the most commonly used shields against neutron radiation from the core of the nuclear reactor.

**Note:**

It is important to understand that alpha, beta, gamma and X-radiation do not cause the body, or any object around the source, to become radioactive. However, most materials in their natural state (including body tissue) contain measurable amounts of radioactivity.

## Measuring Ionizing Radiation

### ***RAD and REM***

The human senses cannot detect radiation or discern whether a material is radioactive. However, a variety of instruments can detect and measure radiation reliably and accurately.

The amount of ionizing radiation, or dose, received by a person is measured in terms of the energy absorbed in the body tissue, and is expressed in **RAD**. One rad is 0.01 joules deposited per kilogram of mass.

Equal exposure to different types of radiation expressed as RAD, do not however, necessarily produce equal biological effects. One rad of alpha radiation, for example, will have a greater effect than one rad of beta radiation. When we talk about radiation effects, we therefore express the radiation as effective dose, in a unit called the **REM** (Roentgen Equivalent Man).

Regardless of the type of radiation, one rem of radiation produces the same biological effect. (100 rem = 1 Sv)

Smaller quantities are expressed in mrem (one thousandth) or  $\mu$ rem (one millionth of a rem). We will use the most common unit, rem, here.

## **What Are The Health Risks From Ionizing Radiation?**

It has been known for many years that large doses of ionizing radiation, very much larger than background levels, can cause a measurable increase in cancers and leukemias (cancer of the blood) after some years delay. It must also be assumed, because of experiments on plants and animals, that ionizing radiation can also cause genetic mutations that affect future generations, although there has been no evidence of radiation-induced mutation in humans. At very high levels, radiation can cause sickness and death within weeks of exposure (see table on next page).

But what are the chances of developing cancer from low doses of radiation? The prevailing assumption is that any dose of radiation, no matter how small, involves a possibility of risk to human health. However there, is no scientific evidence of risk at doses below approximately 5 rem in a short period of time or about 10 rem over a period of one year.

Higher accumulated doses of radiation might produce a cancer that would only be observed several (up to 20) years after the radiation exposure. This delay makes it impossible to say with any certainty which of many possible agents were the cause of a particular cancer. In western countries, about a quarter of people die from cancers, with smoking, dietary factors, genetic factors, and strong sunlight being among the main causes. Radiation is a weak carcinogen, but undue exposure could certainly increase health risks.

On the other hand, large doses of radiation directed specifically at a tumor are used in radiation therapy to kill cancerous cells, and thereby often save lives (usually in conjunction with chemotherapy or surgery). Much larger doses are used to kill harmful bacteria in food, and to sterilize bandages and other medical equipment. Radiation has become a valuable tool in our modern world.

## How Much Ionizing Radiation is Dangerous?

### ***Radiation levels and their effects***

The following table gives an indication of the likely effects of a range of whole body radiation doses and dose rates to individuals:

**1000 rem** as a short-term and whole-body dose would cause immediate illness, such as nausea, decreased white blood cell count, and subsequent death within a few weeks.

Between 200 and 1000 rem in a short-term dose would cause severe radiation sickness with increasing likelihood that this would be fatal.

**100 rem** in a short-term dose is about the threshold for causing immediate radiation sickness in a person of average physical attributes, but would be unlikely to cause death. Above 100 rem, severity of illness increases with dose.

If doses greater than 100 rem occur over a long period, they are less likely to have early health effects, but they create a definite risk that cancer will develop many years later.

Above about **10 rem**, the probability of cancer (rather than the severity of illness) increases with dose. The estimated risk of fatal cancer is 5 of every 100 persons exposed to a dose of 100 rem (i.e. if the normal incidence of fatal cancer were 25%, this dose would increase it to 30%).

**5 rem** is conservatively the lowest dose at which there is any evidence of cancer being caused in adults. It is also the highest dose which is allowed by regulation in any one year of occupational exposure. Dose rates greater than 5 rem/yr arise from natural background levels in several parts of the world but do not cause any discernible harm to local populations.



**2 rem/yr** averaged over 5 years is the limit for radiological personnel such as employees in the nuclear industry, uranium or mineral sands miners and hospital workers (who are all closely monitored).

**1 rem/yr** is the maximum actual dose rate received by any Australian uranium miner.

**300-500 mrem/yr** is the typical dose rate (above background) received by uranium miners in Australia and Canada.

**300 mrem/yr** (approx) is the typical background radiation from natural sources in North America, including an average of almost 200 mrem/yr from radon in air.

**200 mrem/yr** (approx) is the typical background radiation from natural sources, including an average of 70mrem/yr from radon in air. This is close to the minimum dose received by all humans anywhere on Earth.

**30-60 mrem/yr** is a typical range of dose rates from artificial sources of radiation, mostly medical.

**5 mrem/yr**, a very small fraction of natural background radiation, is the design target for maximum radiation at the perimeter fence of a nuclear electricity generating station. In practice, the actual dose is less.

### ***What is the risk estimate?***

According to the Biological Effects of Ionizing Radiation Committee V (BEIR V), the risk of cancer death is 0.08% per rem for doses received rapidly (acute) and might be 2-4 times (0.04% per rem) less than that for doses received over a long period of time (chronic). These risk estimates are an average for all ages, males and females, and all forms of cancer. There is a great deal of uncertainty associated with the estimate.

Risk from radiation exposure has been estimated by other scientific groups. The other estimates are not the exact same as the BEIR V estimates, due to differing methods of risk and assumptions used in the calculations, but all are close.

### ***Risk comparison***

The real question is, "How much will radiation exposure increase my chances of cancer death over my lifetime?" To answer this, we need to make a few general statements of understanding. One is that in the US, the current death rate from cancer is approximately 20%, so out of any group of 10,000 United States citizens, about 2000 of them will die of cancer. Second, the contracting cancer is a random process, where given a set population, we can

estimate that about 20 percent will die from cancer, but we cannot say *which* individuals will die. Finally, that a conservative estimate of risk from low doses of radiation is thought to be one in which the risk is linear with dose. That is, that the risk increases with a subsequent increase in dose. Most scientists believe that this is a conservative model of the risk.

Now the risk estimates: If you were to take a large population, such as 10,000 people and expose them to one rem (to their whole body), you would expect approximately eight additional deaths ( $0.08\% \times 10,000 \times 1 \text{ rem}$ ). So, instead of the 2000 people expected to die from cancer naturally, you would now have 2008. This small increase in the expected number of deaths would not be seen in this group, due to natural fluctuations in the rate of cancer.

What needs to be remembered is that it is not known that eight people will die, but that there is a risk of eight additional deaths in a group of 10,000 people if they would all receive 1 rem instantaneously.

If they would receive the 1 rem over a long period of time, such as a year, the risk would be less than half of this (<4 expected fatal cancers).

Risks can be looked at in many ways. Here are a few ways to help visualize risk:

One way often used is to look at the number of "days lost" out of a population due to early death from separate causes, then dividing those days lost between the population to get an average life expectancy lost due to those causes. The following is a table of life expectancy lost for several causes:

<b>Health Risk</b>	<b>Est. life expectancy lost</b>
Smoking 20 cigarettes a day	6 years
Overweight (15%)	2 years
Alcohol (US Avg.)	1 year
All Accidents	207 days
All Natural Hazards	7 days
Occupational dose (300 mrem/yr)	15 days
Occupational dose (1 rem/yr)	51 days

You can also use the same approach to looking at risks on the job:

<b>Industry Type</b>	<b>Est. life expectancy lost</b>
All Industries	60 days
Agriculture	320 days
Construction	227 days
Mining and quarrying	167 days
Manufacturing	40 days
Occupational dose (300 mrem/yr)	15 days
Occupational dose (1 rem/yr)	51 days

These are estimates taken from the NRC Draft guide DG-8012 and were adapted from B.L. Cohen and I.S. Lee, "Catalogue of Risks Extended and Updates", *Health Physics*, Vol. 61, September 1991.

Another way of looking at risk, is to look at the relative risk of one in a million chances of dying of activities common to our society:

Smoking 1.4 cigarettes (lung cancer)
Eating 40 tablespoons of peanut butter
Spending 2 days in New York City (air pollution)
Driving 40 miles in a car (accident)
Flying 2500 miles in a jet (accident)
Canoeing for 6 minutes
Receiving 10 mrem of radiation (cancer)

Adapted from DOE Radiation Worker Training, based on work by B.L. Cohen, Sc.D.

## **Background Radiation**

Naturally occurring background radiation is the main source of exposure for most people. Levels typically range from about 150-350 mrem per year, but can be more than 5rem/yr. The highest known level of background radiation affecting a substantial population is in Kerala and Madras States in India where some 140,000 people receive doses that average over 1.5 rem/year from gamma radiation, in addition to a similar dose from radon. Comparable levels occur in Brazil and Sudan, with average exposures up to about 4 rem/yr to many people.

Several places are known in Iran, India, and Europe where natural background radiation gives an annual dose of more than 5 rem and up to 26 rem (at Ramsar in Iran). Lifetime doses from natural radiation range

up to a couple thousand rem. However, there is no evidence of increased cancers or other health problems arising from these high natural levels.

## Manmade Radiation

Ionizing radiation is also generated in a range of medical, commercial, and industrial activities. The most familiar and, in national terms, the largest of these sources of exposure is medical X-rays.

Natural radiation contributes about 88% of the annual dose to the population, and medical procedures most of the remaining 12%. Natural and artificial radiations are not different in kind or effect.

## Protection from Radiation

Radiation is very easily detected. There is a range of simple, sensitive instruments capable of detecting minute amounts of radiation from natural and man-made sources. There are three ways in which people are protected from identified radiation sources:

1. **Limiting time:** For people who are exposed to radiation in addition to natural background radiation through their work, the dose is reduced and the risk of illness essentially eliminated by limiting exposure time. Proper job planning is essential in achieving lowest exposure time. Always plan for the unexpected to eliminate delays in the exposure area.
2. **Distance:** In the same way that heat from a fire is less the further away you are, so the intensity of radiation decreases with distance from its source. Distance is the easiest, fastest, and most practical way to limit exposure.
3. **Shielding:** Barriers of lead, concrete or water give good protection from penetrating radiation such as gamma rays. Highly radioactive materials are therefore often stored or handled under water, or by remote control in rooms constructed of thick concrete, or lined with lead.

## Standards and Regulation

Much of the evidence that has led to today's standards derives from the atomic bomb survivors in 1945, which were exposed to high doses incurred in a very short time. In setting occupational risk estimates, some allowance has been made for the body's ability to repair damage from small exposures, but for low-level radiation exposure, the degree of protection may be unduly conservative.

Most countries have their own systems of radiological protection, which are often based on the recommendations of the International Commission on Radiological Protection (ICRP). The authority of the ICRP comes from the scientific standing of its members and the merit of its recommendations.

## Who is in charge?

Ultimately, you are. All of the sources of radiation, other than natural, are regulated by laws passed by Congress. Like any other law, you have your right to voice your views and opinions about it. The regulations that control the use of radioactivity in our country are based upon recommendations of science organizations like the International Commission on Radiological Protection (ICRP), the National Council on Radiation Protection (NCRP), the International Atomic Energy Agency (IAEA), the United Nations (UN), and the Health Physics Society (HPS). Governing bodies like the Environmental Protection Agency (EPA), the Nuclear Regulatory Commission (NRC), the Department of Energy (DOE), and the Food and Drug Administration (FDA) review these recommendations and propose the regulations that industry and government must follow. These are then passed by Congress, if found to be acceptable, and published in the Code of Federal Regulations (CFRs).

**Note:**

The CFR limits the general public to radiation exposure of 100 mrem/year, with no more than 2 mrem of exposure in any one hour (ref. 10 CFR 20.1301).

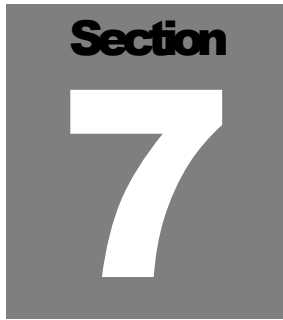
A dark gray square containing the word "Section" in a bold, sans-serif font at the top, and a large, white, stylized number "7" in the center.

**Refer to the Main Board schematic for the following:**

## **Technical Principle of Operation**

---

### ***Detector Input/Amplifier***

Negative-going detector pulses are coupled from the detector through C021 to Amplifier U021. R024 and CR021 protect the input of U021 from inadvertent shorts. Self-biased amplifier U021 provides gain in proportion to R022, divided by R025. Transistor pins 4, 5, and 6 of U021 provide amplification. Pins 10-15 of U021 are coupled as a constant current source to pin 6 of U021. The output is self-bias to  $2 V_{be}$  (approximately 1.4 volts) at pin 7 of U021. This provides just enough bias current through pin 6 of U021 to conduct all of the current from the constant current source. Positive pulses from pin 7 of U021 are coupled to the discriminator (U011) through R031 and C012.

### ***Discriminator***

Positive pulses from amplifier U021 are coupled to pin 2 of U011 comparator. The discrimination level is set by the DISC control connected to pin 3 of U011. As the positive pulses at pin 2 of U011 increase above DISC reference at pin 3, pin 1 goes low, producing a low pulse. Pin 1 of U011 is normally held high (+5 volts) by R014.

The low pulse from pin 1 of U021 is coupled to univibrator U001. U001 shapes and fixes the pulse-width to approximately 10  $\mu$ s. The univibrator is configured in the non-retriggerable mode. Negative pulses from pin 9 of U001 are coupled to the  $\mu$ P for counting.

### ***Low Voltage Supply***

Battery voltage is coupled to DC-DC converter U231. U231 and related components provide +5 V to power the  $\mu$ P, op-amps, and logic circuitry. R135 and R136 provide voltage division for low-battery detection. Pin 6 of U231 provides a low signal when the battery voltage decreases to  $+2.2 \pm 0.1$  Vdc. U121 provides the +2.5 Vdc reference for the HV and DISC control references.

### **High Voltage Supply**

High voltage is developed by blocking oscillator Q241, T141, and C244 and rectified by voltage multiplier CR041-CR043, C041-C043, and C141. High voltage increases as current through R241 increases, with maximum output voltage with Q241 saturated. High voltage is coupled back through R034 to op-amp pin 2 of U131. Resistor network R027, R132 completes the HV division circuit to ground. R027 provides HV limit from 1250-2400 when the HV control on the calibration board is at maximum. The regulated HV output is controlled by the HV1 and HV2 potentiometers located under the CAL cover on the front panel. This control provides the reference for comparator pin 3, U131. During stable operation, the voltage at pin 2 of U131 will equal the voltage at pin 3 of U131. Pin 1 of U131 will cause conduction of Q141 to increase or decrease until the HV finds a level of stability.

### **Detector Overload**

A voltage drop is developed across R031 and sensed by comparator pins 5, 6 and 7 of U131 as detector current increases. When the voltage at pin 5 of U012 goes below pin 6, pin 7 goes low, signaling U111 ( $\mu$ P) to send the OVERLOAD alarm to the LCD. OVL (underneath CAL cover) control provides adjustment for the overload set point.

### **Microprocessor ( $\mu$ P)**

U111 controls all of the data, control inputs, and display information. The clock frequency is crystal-controlled by Y221 and related components at 6.144 MHz. The  $\mu$ P incorporates internal memory (ROM), storing the program information. U1 resets the  $\mu$ P at power-up to initiate the start of the program routine. During the program loop, the  $\mu$ P looks at all the input switches for initiation or status changes and responds accordingly. U122 is a 256 x 8 bit EEPROM used to store the setup parameters. The information is transferred serially from the  $\mu$ P. The EEPROM is non-volatile, meaning it retains memory even after power is removed.

### **Audio**

Click-per-event, divide-by, and alarm audio pulse frequency is generated by the  $\mu$ P and coupled to Q101. Q101 then inverts the pulses and drives the bottom of T101. Bias voltage is provided by the volume control (R002) to the top of T101.

**Refer to the Switch  
Board schematic for  
the following:**

### ***S1 (FUNCTION)***

S1 is a 16-position binary rotary switch, which selects the programmable parameters for the Model 2241-2. The switch selects the parameters using the hexadecimal numbering system via buss lines SW1-SW4.

### ***S2-S4***

S2-S4 are pushbutton switches that enter/change the variables for each of the 16 parameters.

### ***U1***

U1 is a +5 V powered RS-232 driver/receiver used to interface the Model 2241-2 to a computer.

**Refer to Display  
Board schematic  
for the following:**

### ***LCD Drive***

U1 and U2 are serial input 32-bit LCD drivers. The data is loaded serially into the 32-bit shift registers (internal) via the "D" IN input. The LOAD input instructs the shift register to receive data while the CLOCK input shifts the data through the 32-bit registers. After all the data is loaded, the LOAD line is pulsed by the  $\mu$ P, instructing the registers to transfer the data to the LCD drivers. The backplane (BP) signal from U2 provides the reference signal (approximately 125 Hz at 5 Vdc) to the LCD (DSP1) BP connection. When a segment is illuminated, the signal to that segment will be out-of-phase with the BP signal. If the segment is OFF, the signal will be in-phase with the BP signal.

### ***Backlight Drive***

Depressing the LIGHT button instructs the  $\mu$ P to set the BACKLIGHT line, pin 31 on  $\mu$ P, "low" for the predetermined backlight ON time. (Refer to main board schematic for details.) A "low" condition on pin 31 causes Q212 to conduct sending +3 V to P8-3 on Display board. With +3 V at P8-3 (refer to display board schematic), backlight oscillator Q011, T011, and related components starts to oscillate, producing a 2.5 kHz sine wave signal. The signal is amplified by T011 to 150 volts peak-to-peak to drive the LCD backlight.



**Section**  
**8**

## Instrument Setup & Calibration

---

### Factory Settings

If special calibration requirements are not specified at the time the instrument is ordered, calibration will be made based on the default settings shown below:

	<u>DET#1</u>	<u>DET#2</u>
Color Dot:	Red	Yellow
Probe model:	44-9	44-2
Units/Time-base:	cpm	R/hr
Rate Alarm:	50 kcpm	50 $\mu$ R/hr
Rate Alert:	20 kcpm	20 $\mu$ R/hr
Scaler Alarm:	85000	85000
Scaler count time:	12 sec.	12 sec.

### Entering or Changing Switch Board Parameters

On the switch board, select the desired parameter to enter or change by using the corresponding FUNCTION switch position. Depress the ENTER button, and a character on the LCD will start to flash. The flashing character indicates that the program is in the parameter change mode.

To change the character, press the UP button until the desired variable is reached. To shift to another character, increment the LEFT pushbutton until the desired character is reached. The LEFT pushbutton switch enables the operator to sequence through all the characters on the LCD associated with a particular parameter.

Once the desired data is entered, depress the ENTER button. The LCD characters should stop flashing and the new parameter data should display.

**Note:**

The DETECTOR SELECT switch allows the Model 2241-3 to have four sets of operating parameters.

## THE FUNCTION SWITCH

**FUNCTION Switch:** This is a 16-position rotary switch labeled “0-9” and “A-F.” This switch selects a parameter setup mode for the Model 2241-3. If the board is not installed, the normal operation mode (counting mode) is selected. If the switch board is installed, the selector switch must be set to the 0 position for normal instrument operation.

The following may be changed using the switch board and are discussed in detail in this section:

- detector parameters
- current detector setup in use
- RS-232 communication baud rate
- RS-232 data dump mode
- RS-232 detector parameters set/read mode

## FUNCTION SWITCH POSITION DESCRIPTIONS AND VARIABLES

**POSITION 0:** NORMAL OPERATION places the Model 2241-3 in the normal (counting) operating mode. Unplugging the switch board from the Model 2241-3 main board defaults to the normal operating mode.

**POSITION 1:** DEAD TIME ( $\mu\text{s}$ ) allows changing the detector dead time correction for the current detector setup. Setting this parameter to 0 disables dead time correction. The dead time adjusts from 0 to 9999 microseconds ( $\mu\text{s}$ ). The incoming counts are adjusted for dead time using the following formula:

$$n = \frac{m}{1 - m\tau}$$

Where,

n = corrected counts per second

m = incoming count per second

τ = system dead time

$$CC = \frac{cps \times time \ base}{rate}$$

**POSITION 2:** CALIBRATION CONSTANT allows changing the calibration constant for the current detector setup. The calibration constant (CC) adjusts from 0.001 to  $280 \times 10^9$ . The calibration constant converts counts/time base to units/time base. The CC must be set to 1 to readout in cps (counts per second) or cpm (counts per minute).

**CC CONVERSION TABLE**

<u>Conversion Rate</u>	<u>Multiply by to get CC</u>
cps/μR/hr	$3.6 \times 10^9$
cps/mR/hr	$3.6 \times 10^6$
cps/R/hr	$3.6 \times 10^3$
cpm/μR/hr	$6.0 \times 10^7$
cpm/mR/hr	$6.0 \times 10^4$
cpm/R/hr	$6.0 \times 10^1$
cps/μSv/h	$3.6 \times 10^7$
cps/mSv/h	$3.6 \times 10^4$
cps/Sv/h	$3.6 \times 10^1$
cpm/μSv/h	$6.0 \times 10^5$
cpm/mSv/h	$6.0 \times 10^2$
cpm/Sv/h	0.6

**Example:**

The Model 44-9 GM detector produces approximately 3300 cpm/mR/hr for <sup>137</sup>Cs:  $\rightarrow 6.0 \times 10^4 \times 3300 = 198 \times 10^6$  for CC.

**POSITION 3:** DISPLAY UNITS selects the display units for the associated detector setup number. The Model 2241-3 and detector may be calibrated in either exposure rate (R/hr or Sv/h) by entering the appropriate Calibration Constant (position 2) and Dead Time correction

(position 1). The Model 2241-3 will automatically convert to the correct reading when switching between R and Sv.

The time base for count “C” is set independently in position 4. The display units may be set to:

R/hr (Roentgens per hour)

Sv/h (Sieverts per hour)

C/time base (Counts per time)

The display is auto-ranging with the appropriate multiplier symbol appearing in front of the “R,” “Sv,” or “C,” indicating the range:

$\mu$ R/hr, mR/hr, R/hr

$\mu$ Sv/h, mSv/h, Sv/h

C/s, kC/s, C/m, kC/m

**POSITION 4:** TIME BASE: CPS OR CPM selects the display time base for the current detector setup. This time base only applies if the units are set to C/ (Counts/time). The time base for R/hr and Sv/h is fixed in “hr.” For “true” reading (Pulser calibration) cpm or cps calibrations, set the Calibration Constant (CC, parameter 2) to read “1.” For geometry calibrations, the detector efficiency can be entered for CC.

**Example:**

For alpha scintillation detector with 25%  $2\pi$  efficiency, enter “250 10<sub>3</sub>” in the CC parameter setup.

The display time base may be set to:

seconds (s)

minutes (m)

**POSITION 5:** AUDIO DIVIDE-BY selects the audible click-per-event division rate for the current detector setup. If the AUD ON/OFF switch is in the OFF position, no audible click-per-event will be heard.

This parameter ranges from:

0 = Divide By 1

1 = Divide By 10

2 = Divide By 100

3 = Divide By 1000

**POSITION 6:** RESPONSE TIME allows changing the time constant (TC) for the current detector setup. If the response is set to 0, the Model 2241-3 automatically calculates (for variable mode) the time constant based on the incoming cps. If a variable of 1-199 is entered for TC, the response time becomes fixed.

**Variable Response** - Response time is varied in proportion to the incoming count rate. The two-position F/S (Fast/Slow) toggle switch selects the maximum time constant (TC) for the variable mode. The fast position varies the TC from 4-25 seconds, and the slow position varies from 4-60 seconds.

**Fixed Response** - The Fast (F) response position is programmable from 2-50 seconds, and the slow response is five times slower than the fast TC. For MDA-type measurements, the fixed response time mode is recommended.

**POSITION 7:** RATEMETER ALARM/ALERT allows changing the ratemeter alarm for the current detector setup. The units of this alarm are the same as the units for the ratemeter display. The fifth push of the left button allows the decimal point to be moved. The ratemeter alarm adjusts from 1 to 999 R/hr (or Sv/h) or 1 to 999 kcpm or 1 to 100 kcps. The units of the alarm are determined by the units for the ratemeter.

**POSITION 8:** SCALER ALARM/COUNT TIME sets the scaler alarm variable from 1-999999, corresponding to the accumulated scaler count. After the scaler alarm variable is entered, the scaler count time is prompted. The scaler count time is adjustable from 1-9999 seconds.

**POSITION 9:** NOT USED

**POSITION A:** NOT USED

**POSITION B:** LCD Backlight ON TIME is the amount of time that the LCD backlight will stay on after pressing the front-panel switch labeled LIGHT. This value is stored in EEPROM.

Available values are:

5 seconds  
30 seconds  
60, 90 seconds  
180, 240 seconds.

**POSITION C:** SET MINIMUM DISPLAY sets the ratemeter minimum displayable reading. Depressing the RESET button displays the minimum ratemeter units. The readout will auto-range up to the maximum displayable, but will display 0 for ratemeter readings below the user-programmed minimum variable.

Minimum displayable values are:

00.0  $\mu$ , 000  $\mu$ , 0.00 m, 00.0 m, 000 m, 0.00, 00.0, 000 R/hr  
.000  $\mu$ , 000  $\mu$ , 00.0 m, 000 m, 0.00, 00.0, 000 Sv/h  
0.00, 00.0, 000, 0.00 k, 00.0 k, 000 kcpm or cps

**POSITION D:** RS-232 DATA DUMP MODE, allows the RS-232 port to dump ratemeter data every two seconds. The Model 2241-3 is fully functional during RS-232 data dump with the exception of the audio function. The LCD will alternate between display of the ratemeter and the word “dUP” (representing "dump").

**POSITION E:** RS-232 DETECTOR PARAMETERS SETUP MODE allows the RS-232 port to accept/send a string of parameters corresponding to the current detector setup values.

**POSITION F:** BAUD RATE configures the RS-232 port for the following baud: 150, 300, 600, 1200, 2400, 4800, 9600, and 19200. The data is eight data bits, one stop bit with no parity bit. This value is stored in EEPROM. The baud rate can only be programmed through the switch board.

**RS-232 PORT CONNECTOR:** This nine-pin “D” type connector is designed as a DCE port. A straight wire cable (extension cable) connects the Model 2241-3 to a computer’s nine-pin RS-232 port.

**RS-232 CONNECTOR PIN OUT:**

<u>PIN</u>	<u>FUNCTION</u>
1	NC (No Connection)
2	DATA OUT
3	DATA IN
4	NC
5	NC
6	NC
7	HANDSHAKING IN
8	HANDSHAKING OUT
9	NC

**Note:**

Ludlum Measurements, Inc. offers a PC compatible software program, which incorporates the read/write commands necessary to communicate between the PC and the Model 2241-3. The program also incorporates an algorithm to calculate the detector Calibration Constant and Dead Time Constant. The software is offered in a DOS version (part number 1370-025) or a WINDOWS version (part number 1370-024). Read the Software License Agreement at the end of this section before installing any LMI software.

## Calibration

The Model 2241-3 calibration routine consists of entering detector parameters into memory by way of the switch board and adjusting the CAL controls (HV and DISC) for the specific detector operating requirements.

The first subsection of calibration will give a general overview of detector setup, including the determination of various detector operating voltages (HV) and the adjustment of counter input sensitivity (DISC).

The next subsection deals with pulse generator counts per minute calibration. The counts per minute parameter setup is used in the initial

instrument checkout procedure, and the variables are saved under detector setup number “1” when shipped from Ludlum Measurements, Inc.

The following subsection deals with exposure rate calibration. The detector Calibration Constant (CC) and Dead Time Correction (DTC) are the two primary parameters used in the exposure rate calibrations (R/hr and Sv/h). These two constants are alternately varied to achieve linearity at the detector non-linear operating regions. An example of the Ludlum Model 44-9 GM detector calibration is given at the end of this section to illustrate the algorithm used in determining the CC and DTC variables.

### **GENERAL DETECTOR SETUP INFORMATION**

The operating point for the instrument and probes is established by setting the probe voltage and instrument sensitivity (HV and DISC). The proper selection of this point is the key to instrument performance. Efficiency, background sensitivity, and noise are fixed by the physical makeup of the given detector and rarely vary from unit to unit. However, the selection of the operating point makes a marked difference in the apparent contribution of these three sources of count.

In setting the operating point, the final result of the adjustment is to establish the system gain so that the desirable signal pulses (including background radiation) are above the discrimination level, and the unwanted pulses from noise are below the discrimination level, and are therefore, not counted.

The total system gain can be controlled by adjusting either the instrument sensitivity or the high voltage. HV controls the gain of the detector; and DISC (Discriminator) controls the instrument counting threshold (sensitivity).

In the special case of GM detectors, a minimum voltage must be applied to establish the Geiger-Mueller characteristic. Further changes in HV will have little effect on this type of detector.

**GM Detectors:** The output pulse height of the GM detector is not proportional to the energy of the detected radiation. Adjusting DISC will have minimal effect on observed count rate unless the DISC setting is so low that the instrument will double-pulse.



For most GM detectors, set DISC for 30-40 millivolts and adjust HV to the GM detector recommended high voltage. Most GM detectors operate at 900 volts, although some miniature detectors operate at 450-550 volts. If a recommended setting is unavailable, plot count rate versus HV to produce a plateau graph. Adjust the HV for 25-50 volts above the knee or start of the plateau. For mixed detector use, both sensitivity and high voltage may be tailored for other detectors as long as the GM detector is operated within the recommended voltage range. Caution must be observed in lowering the input sensitivity to ensure that the counter does not double or multi-pulse.

**Alpha Air-Proportional Detectors:** For air proportional alpha detectors, set the DISC for 2 millivolt discrimination. Adjust HV until the detector just breaks down (shown by a rapid increase of count rate without a source present). Measure the HV output, then decrease the HV setting to operate 100 volts below breakdown.

**Proportional Detectors:** For proportional detectors, set the DISC control for 2-millivolt discrimination (near maximum clockwise). Expose the detector to a check source and plot count rate versus HV, similar to the one in the figure below. Refine the HV adjustment for optimum source efficiency with a minimum acceptable background count.

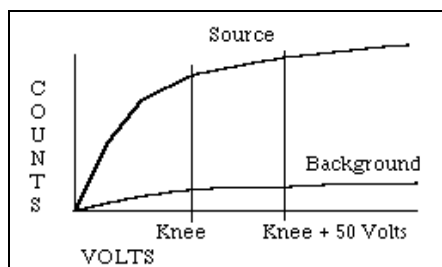

**Scintillators:** Set the DISC for 10 millivolts. Plot background and source counts versus HV to produce a plateau graph similar to the one in the figure. Adjust the HV to 25-50 volts above the knee or start of the plateau. This provides the most stable operating point for the detector.

### COUNTS PER MINUTE (C/M) CALIBRATION

This procedure will setup the Model 2241-3 for the counts per minute (C/m) mode of operation. Refer to Section 8 (Page 8-2 and following) for more information on setting up parameter variables.

A Ludlum Model 500 Pulser or equivalent is required. If the pulser does not have a high-voltage display, use a high-impedance voltmeter with at least 1000 megohms input resistance to measure the detector high voltage.

Switch the SCA/RATE switch to the RATE position. Select position DET1 on the detector selector switch located on the front panel.

Select FUNCTION switch positions 1-6 and adjust for the following parameters:

<u>Switch Pos.</u>	<u>Parameter</u>	<u>Function</u>
1	0000 s <sub>6</sub>	Dead Time
2	0100 -2	Calibration Constant
3	c/	Display Units
4	m	Timebase
5	1	Audio Divide-by
6	000 s	Response Time

Position 7 selects the desired ratemeter ALERT and ALARM trip points.

If the parameters are undetermined, arbitrarily choose “0050 kC/m” for the alarm and “0045 kC/m” for the alert to confirm operation of the alert/alarm function.

Position 8 selects the scaler alarm parameter and the scaler count time.

If the values are unknown, set the scaler alarm to “4500<sub>ALARM00</sub>” and the count time to “0060” (60 second count time).

Position 9 is not used, and position A is not used.

Switch to position B and enter “15” for a 15-second backlight ON time.

Switch to position C and enter “00.0 C/m” for the minimum displayable value.

Select position 0 to return to normal operation.

Connect the Model 500 Pulser to detector input and adjust HV and DISC to the specific detector operating parameters.

- Adjust the pulser amplitude to 1.5 times the Model 2241-3 discrimination level.
- Adjust the pulser output to 800 cpm and confirm that the Model 2241-3 reads 800 cpm  $\pm 10\%$  on the ratemeter setting.
- Adjust the pulser output to 200 cpm and confirm that the Model 2241-3 reads 200 cpm  $\pm 10\%$  on the ratemeter setting.
- Adjust the pulser output to 800 cpm, take a one-minute count and confirm that the digital scaler readout displays 800 cpm  $\pm 2\%$ .
- Adjust the pulser output to 200 cpm, take a one-minute count and confirm that the digital scaler readout displays 200 cpm  $\pm 2\%$ .
- Confirm that the 20% and 80% readings for the upper decades are within the pulser input by decading the pulser count output.
- Confirm that the scaler readout is within 2% of the pulser input rate.
- Ensure that the ALERT and ALARMS function by inputting the preset alarm levels as to initiate the alert and alarm conditions.

### **R/hr CALIBRATION**

The following calibration procedure assumes that detector Calibration Constant (CC) and Dead Time Constant (DTC) are already known. If these constants must be determined, reference the following subsection, "Determining CC and DTC".

Switch the toggle switch to DET2. Detector setup number "1" is usually reserved for the Counts/minute parameter calibration. Rotate the FUNCTION switch counterclockwise to position 1 and enter the detector Dead Time in  $\mu\text{s}$ . Rotate to position 2 and enter the Calibration Constant. Enter the desired parameters for positions 3-F. Switch to position 0 for normal operation.

Expose the detector to calibrated radiation fields extending from the lower to the upper operating range of the detector. Confirm that the linearity is within 10% of each respective reading. If the readings are off on the lower detector operating region, vary CC. If the readings are off at the upper end of the detector operating region, adjust DTC.

**DETERMINING CC AND DTC**

This procedure contains the algorithm (*hi-lo method*) for determining the CC (Calibration Constant) and the DTC (Dead Time Correction). An example of the Ludlum Model 44-9 GM detector calibration is used in conjunction with the algorithm calculations to aid in solving the equations.

**Note:**

Ludlum Measurements, Inc. offers a PC-compatible software program, which incorporates the read/write commands necessary to communicate between a PC and the Model 2241-3. The program also incorporates the algorithm to calculate the detector CC and DTC. The software is offered in a DOS version (part number 1370-025) or a WINDOWS version (part number 1370-024). Read the Software License Agreement at the close of this section prior to installing any LMI software.

**Hi-Lo Method:** The hi-lo method refers to the placement of the detector in a radiation field using a two-point (CC and DT) calibration to make linear the detector response, even in the non-linear operating regions of the detector. The low radiation field (CC) should be a field that yields from 2 to 5 % count loss. The high radiation field (DT) should be a field that yields from 30 to 60 % count loss. The algorithm ignores background counts, and therefore, the low field must be at least 10 times the background count.

The following summary lists the calibration constraints.

**Calibration and Dead Time Calibration Constraints**

<u>FIELD</u>	<u>CONSTRAINT</u>
BACKGROUND	*10 times less than low field
LOW FIELD	Yields from 2 to 5 % count loss
HIGH FIELD	Yields from 30 to 60 % count loss

\* This constraint only applies when using two sources (two fields) or a radiation range calibrated without background consideration.

**Preliminary CPS Setup**

Refer to Section 8, Subsection “Function Switch Position Descriptions and Variables,” for cps readout variables.

Select position DET1 on the detector selector switch located on the front panel. Starting with FUNCTION switch position 1, enter the following variables:

<u>SWITCH POS.</u>	<u>PARAMETER</u>	<u>FUNCTION</u>
1	0000s <sub>6</sub>	Dead Time
2	0100 -2	Calibration Constant
3	C/	Display Units
4	m	Timebase
5	N/A	Audio Divide-By
6	N/A	Response Time
7	N/A	Ratemeter Alm./Alert
8	0060 s	ScalerAlm./Count Time
9	Not Used	
A	Not Used	
B	N/A	LCD Backlight
C	000 C/s	Set Minimum Display
D-F	N/A	RS-232 Parameters

Equation 1

$$CPS^{LO_{2\%}} = \frac{1}{49 \times DT}$$

Equation 2

$$CPS^{LO_{5\%}} = \frac{1}{19 \times DT}$$

Equation 3

$$CPS^{HI_{30\%}} = \frac{1}{2.3333 \times DT}$$

Equation 4

$$CPS^{HI_{60\%}} = \frac{1.5}{DT}$$

The equations to the left (Equations 1-4) determine the *hi* and *lo* radiation fields used to acquire counts for the CC and DTC algorithm. These calculations require an unknown variable, DT (Dead Time). Typical dead times for some of the standard LMI detectors are referenced in the table at the end of this section. The *lo* count field should be a field which yields between 2 and 5% count loss. The *hi* count field ( $CPS^{HI}$ ) should be a field that yields between 30 and 60% count loss.

Reference the table at the end of this section to determine the cps/exposure rate (cps/ER). The conversion can be determined by placing the detector in a radiation field, which produces from 50 to 200 cps. Calculate the count/exposure rate using the equation to the left.

$$\frac{\text{cps}}{\text{radiation field in exposure rate units}} = \text{cps} / \text{ER}$$

For example, exposing an LMI Model 44-9 to a 2 mR/hr <sup>137</sup>Cs field yields

approximately 110 cps so that:

$$\frac{110 \text{ cps}}{2 \text{ mR/hr}} = 55 \text{ cps/mR/hr}$$

The typical dead time for a Model 44-9 is approximately 85 μs. Therefore, using 85 μs for “DT” in equations 1-4, the *lo* field should be between 240 and 619 cps, and the *hi* field is between 5040-17,650 cps. Dividing the cps values by the 55 cps/mR/hr conversion equates to between 4-11 mR/hr for the *lo* field and 91-320 mR/hr for the *hi* field.

Select a calibrated field between the *lo* and *hi* data points determined above:

$$lo (CAL_{lo}) = 8 \text{ mR/hr}$$

$$hi (CAL_{hi}) = 200 \text{ mR/hr}$$

#### **The following procedure outlines the hi-lo method**

Abbreviations used:

units = Sv, R, counts.

CAL<sub>lo</sub> = *lo* field calibration point.

CAL<sub>hi</sub> = *hi* field calibration point.

CORR<sub>lo</sub> = recorded field at low calibration point.

CORR<sub>hi</sub> = recorded field at high calibration point.

DT = dead time constant entered into Model 2241.

CC = calibration constant entered into Model 2241.

$f_d$  and  $a_d$  are intermediate steps in calculating DT.

$f_{cal}$  is an intermediate step in calculating CC.

**CC and DTC Algorithm**

Equations (5) and (6) convert units per time (R/hr Display Units) to units per second:

$$\frac{\text{units}}{\text{time}} \Rightarrow \frac{\text{units}}{\text{second}}$$

Insert the cps *lo* data point (8 mR/hr for the Model 44-9 example) determined from equations (1) and (2):

Equation 5

$$CAL_{lo} = (0.008 \frac{R}{h}) \times (\frac{1 h}{60 m}) \times (\frac{1 m}{60 s}) = 2.22 \times 10^{-6} s$$

Insert the cps *hi* data point (200 mR/hr for the Model 44-9 example) determined from equations (3) and (4):

Equation 6

$$CAL_{hi} = (0.200 \frac{R}{h}) \times (\frac{1 h}{60 m}) \times (\frac{1 m}{60 s}) = 55.6 \times 10^{-6} s$$

Place the detector in the low field and enter the counts per second:

Equation 7

$$CORR_{lo} = \frac{SAMPL_{lo}}{\text{count time}} = \frac{\text{counts}}{s}$$

**Note:**

The low field count sample should be  $\geq 3000$  counts. Use the scaler and adjust the count time to accumulate count  $\geq 3000$ .

As an example, assume a 60-second count sample in a low field of 8 mR/hr:

Example

$$CORR_{lo} = \frac{26,427}{60} = 440 \text{ C/s}$$

Place detector in the high field and enter the counts per second:

Equation 8

$$CORR_{hi} = \frac{SAMPL_{hi}}{\text{count time}} = \frac{\text{counts}}{s}$$

Counts/second sample in high field of 200 mR/hr:

Example

$$CORR_{hi} = \frac{5830}{1} = 5830 \text{ C/s}$$

Insert the values calculated in equations (5), (6), (7), and (8) and solve for  $f_d$ :

Equation 9

$$f_d = CAL_{hi} - \frac{CORR_{hi} \times CAL_{lo}}{CORR_{lo}} = \frac{\text{units}}{s}$$

Example

$$f_d = 55.6 \times 10^{-6} - \frac{5830 \times 2.22 \times 10^{-6}}{440} = 26.2 \times 10^{-6} \frac{R}{s}$$

Solve for  $a_d$ :

Equation 10

$$a_d = (CAL_{hi} \times CORR_{hi}) - (CAL_{lo} \times CORR_{hi}) = \frac{\text{units} \times \text{count}}{s^2}$$

Example

$$a_d = (55.6 \times 10^{-6} \times 5830) - (2.22 \times 10^{-6} \times 5830) = 31.1 \times 10^{-2} \frac{R\text{Count}}{s^2}$$



Enter the results of equations (9) and (10) into equation (11) to solve for DT:

Equation 11

$$DT = \frac{f_d}{a_d} = \frac{s}{\text{count}}$$

Example

$$DT = \frac{26.2 \times 10^{-6}}{31.1 \times 10^{-2}} = 8.4 \times 10^{-5} \frac{\text{seconds}}{\text{count}} \text{ or } 84 \times 10^{-6} \text{ sec}$$

Solve for  $f_{cal}$ :

Equation 12

$$f_{cal} = CAL_{lo} - (CAL_{lo} \times CORR_{lo} \times DT) = \frac{\text{units}}{s}$$

Example

$$f_{cal} = 2.22 \times 10^{-6} - (2.22 \times 10^{-6} \times 440 \times 84 \times 10^{-6}) = 2.14 \times 10^{-6} \frac{R}{s}$$

Enter the result of equation (12) into:

Equation 13

$$CC = \frac{CORR_{lo}}{f_{cal}} = \frac{\text{count}}{\text{units}}$$

and solve for CC:

Example

$$CC = \frac{440}{2.14 \times 10^{-6}} = 206 \times 10^6 \frac{\text{counts}}{R}$$

Enter the CC and DT values (positions 1 and 2 of the FUNCTION switch), derived from the equations above. Perform an “R/hr calibration” as described in the previous subsection in order to ensure that the instrument and detector have been correctly calibrated.

**Model 44-9 Detector Parameter Setup**

<u>FUNCTION</u>	<u>PARAMETER</u>
1	0084 s <sub>.6</sub>
2	0206 <sub>06</sub>
4	N/A
5-8	as desired
B-C	as desired
D-F	if applicable

**Typical Count Rate and Dead Time for LMI Detectors**

<u>MODEL &amp; TYPE</u>	<u>COUNT RATE</u>	<u>DEAD TIME</u> <u>in <math>\mu</math>s (microseconds)</u>
44-6, GM	20 cps/mR/hr	90-110 $\mu$ s
44-9, GM	55 cps/mR/hr	80-90 $\mu$ s
44-7, GM	35 cps/mR/hr	240-290 $\mu$ s
133-2, GM	17.5 cps/mR/hr	40-55 $\mu$ s
133-4, GM	2 cps/mR/hr	40-55 $\mu$ s
133-6, GM	0.3 cps/mR/hr	40-55 $\mu$ s
44-2, Gamma Scint.	2800 cps/mR/hr	8-12 $\mu$ s*
44-10, Gamma Scint.	15,000 cps/mR/hr	18-20 $\mu$ s
44-3, Low-Energy Gamma Scint.	N/A, operated in Counts/units mode	8-12 $\mu$ s*
44-21, Beta/Gamma Scint.	N/A, operated in Counts/units mode	8-12 $\mu$ s*
43-5, Alpha Scint.	N/A, operated in Counts/units mode	20-28 $\mu$ s

**Note:**

The data represented in the table above is typical. Actual values may vary among detector and instrument combinations. This table represents some of the common detectors operated with the Model 2241-3. Consult the LMI sales department for information concerning detectors not listed in the table above.

\*The dead time values for these scintillation detectors are due to the dead time of the Model 2241-3 electronics.

## Loading Default Parameters

To load the default parameters for all detector setups, hold down the UP pushbutton on the switch board, while turning the instrument on, until DEF is displayed on the LCD. The table below shows the default values.

Model 2241-3	Cpm	uR/hr	R/Hr	mR/hr
	Setup 01	Setup 02	Setup 03	Setup 04
Dead Time	0 $\mu$ s	0 $\mu$ s	0 $\mu$ s	0 $\mu$ s
Cal Const	100e-2	105e+8	108e+4	198e+6
Rate Alarm	50.0 kcpm	50 $\mu$ R/hr	5 R/hr	5 mR/hr
Scaler Alarm	85000	85000	85000	85000
Count Time	12 s	12 s	12 s	12 s
Time Base	Minutes	Seconds	Seconds	Seconds
Units	cpm	R/hr	R/hr	R/hr
Audio Divide By	1	1	1	1
Response	0	0	0	0
Check Source	0	0	0	0
Percent CS	0	0	0	0
Rate Alert	20.0 kcpm	20 $\mu$ R/hr	2 R/hr	2 mR/hr
Minimum Display	0.00 cpm	00.0 $\mu$ R/hr	00.0 uR/hr	00.0 uR/hr
Baud Rate	9600			
LCD Time Off	5 s			
Detector	0			

**LUDLUM MEASUREMENTS, INC.**

501 OAK ST., P.O. BOX 810

SWEETWATER, TX 79556

325/235-5494 FAX: 325/235-4672

---

## Software License Agreement

---

**Rev. (number) 1.0****Written by (or Revised by):****Date:** 20 Jan 06**Approved by:****Date:** 20 JAN 06

---

BY INSTALLING THIS SOFTWARE, YOU ARE CONSENTING TO BE BOUND BY THIS AGREEMENT. IF YOU DO NOT AGREE TO ALL OF THE TERMS OF THIS AGREEMENT, DO NOT INSTALL THE PRODUCT.

**Single User License Grant:** Ludlum Measurements, Inc. ("Ludlum") and its suppliers grant to Customer ("Customer") a nonexclusive and nontransferable license to use the Ludlum software ("Software") in object code form solely on a single central processing unit owned or leased by Customer or otherwise embedded in equipment provided by Ludlum.

Customer may make one (1) archival copy of the Software provided Customer affixes to such copy all copyright, confidentiality, and proprietary notices that appear on the original.

EXCEPT AS EXPRESSLY AUTHORIZED ABOVE, CUSTOMER SHALL NOT: COPY, IN WHOLE OR IN PART, SOFTWARE OR DOCUMENTATION; MODIFY THE SOFTWARE; REVERSE COMPILE OR REVERSE ASSEMBLE ALL OR ANY PORTION OF THE SOFTWARE; OR RENT, LEASE, DISTRIBUTE, SELL, OR CREATE DERIVATIVE WORKS OF THE SOFTWARE.

Customer agrees that aspects of the licensed materials, including the specific design and structure of individual programs, constitute trade secrets and/or copyrighted material of Ludlum. Customer agrees not to disclose, provide, or otherwise make available such trade secrets or copyrighted material in any form to any third party without the prior written consent of Ludlum. Customer agrees to implement reasonable security measures to protect such trade secrets and copyrighted material. Title to Software and documentation shall remain solely with Ludlum.

**LIMITED WARRANTY.** Ludlum warrants that for a period of ninety (90) days from the date of shipment from Ludlum: (i) the media on which the Software is furnished will be

free of defects in materials and workmanship under normal use; and (ii) the Software substantially conforms to its published specifications. Except for the foregoing, the Software is provided AS IS. This limited warranty extends only to Customer as the original licensee. Customer's exclusive remedy and the entire liability of Ludlum and its suppliers under this limited warranty will be, at Ludlum or its service center's option, repair, replacement, or refund of the Software if reported (or, upon request, returned) to the party supplying the Software to Customer. In no event does Ludlum warrant that the Software is error free or that Customer will be able to operate the Software without problems or interruptions.

This warranty does not apply if the software (a) has been altered, except by Ludlum, (b) has not been installed, operated, repaired, or maintained in accordance with instructions supplied by Ludlum, (c) has been subjected to abnormal physical or electrical stress, misuse, negligence, or accident, or (d) is used in ultrahazardous activities.

DISCLAIMER. EXCEPT AS SPECIFIED IN THIS WARRANTY, ALL EXPRESS OR IMPLIED CONDITIONS, REPRESENTATIONS, AND WARRANTIES INCLUDING, WITHOUT LIMITATION, ANY IMPLIED WARRANTY OF MERCHANTABILITY, FITNESS FOR A PARTICULAR PURPOSE, NONINFRINGEMENT OR ARISING FROM A COURSE OF DEALING, USAGE, OR TRADE PRACTICE, ARE HEREBY EXCLUDED TO THE EXTENT ALLOWED BY APPLICABLE LAW.

IN NO EVENT WILL LUDLUM OR ITS SUPPLIERS BE LIABLE FOR ANY LOST REVENUE, PROFIT, OR DATA, OR FOR SPECIAL, INDIRECT, CONSEQUENTIAL, INCIDENTAL, OR PUNITIVE DAMAGES HOWEVER CAUSED AND REGARDLESS OF THE THEORY OF LIABILITY ARISING OUT OF THE USE OF OR INABILITY TO USE THE SOFTWARE EVEN IF LUDLUM OR ITS SUPPLIERS HAVE BEEN ADVISED OF THE POSSIBILITY OF SUCH DAMAGES. In no event shall Ludlum's or its suppliers' liability to Customer, whether in contract, tort (including negligence), or otherwise, exceed the price paid by Customer. The foregoing limitations shall apply even if the above-stated warranty fails of its essential purpose. SOME STATES DO NOT ALLOW LIMITATION OR EXCLUSION OF LIABILITY FOR CONSEQUENTIAL OR INCIDENTAL DAMAGES.

The above warranty DOES NOT apply to any beta software, any software made available for testing or demonstration purposes, any temporary software modules or any software for which Ludlum does not receive a license fee. All such software products are provided AS IS without any warranty whatsoever.

This License is effective until terminated. Customer may terminate this License at any time by destroying all copies of Software including any documentation. This License will terminate immediately without notice from Ludlum if Customer fails to comply with any provision of this License. Upon termination, Customer must destroy all copies of Software.

Software, including technical data, is subject to U.S. export control laws, including the U.S. Export Administration Act and its associated regulations, and may be subject to export or import regulations in other countries. Customer agrees to comply strictly with

all such regulations and acknowledges that it has the responsibility to obtain licenses to export, re-export, or import Software.

This License shall be governed by and construed in accordance with the laws of the State of Texas, United States of America, as if performed wholly within the state and without giving effect to the principles of conflict of law. If any portion hereof is found to be void or unenforceable, the remaining provisions of this License shall remain in full force and effect. This License constitutes the entire License between the parties with respect to the use of the Software.

Restricted Rights - Ludlum's software is provided to non-DOD agencies with RESTRICTED RIGHTS and its supporting documentation is provided with LIMITED RIGHTS. Use, duplication, or disclosure by the Government is subject to the restrictions as set forth in subparagraph "C" of the Commercial Computer Software - Restricted Rights clause at FAR 52.227-19. In the event the sale is to a DOD agency, the government's rights in software, supporting documentation, and technical data are governed by the restrictions in the Technical Data Commercial Items clause at DFARS 252.227-7015 and DFARS 227.7202. Manufacturer is Ludlum Measurements, Inc. 501 Oak Street Sweetwater, Texas 79556.

**Section**  
**9****Recycling**

Ludlum Measurements, Inc. supports the recycling of the electronic products it produces for the purpose of protecting the environment and to comply with all regional, national, and international agencies that promote economically and environmentally sustainable recycling systems. To this end, Ludlum Measurements, Inc. strives to supply the consumer of its goods with information regarding reuse and recycling of the many different types of materials used in its products. With many different agencies – public and private – involved in this pursuit, it becomes evident that a myriad of methods can be used in the process of recycling. Therefore, Ludlum Measurements, Inc. does not suggest one particular method over another, but simply desires to inform its consumers of the range of recyclable materials present in its products, so that the user will have flexibility in following all local and federal laws.

The following types of recyclable materials are present in Ludlum Measurements, Inc. electronic products, and should be recycled separately. The list is not all-inclusive, nor does it suggest that all materials are present in each piece of equipment:

Batteries	Glass	Aluminum and Stainless Steel
Circuit Boards	Plastics	Liquid Crystal Display (LCD)

Ludlum Measurements, Inc. products, which have been placed on the market after August 13, 2005, have been labeled with a symbol recognized internationally as the “crossed-out wheelie bin.” This notifies the consumer that the product is not to be mixed with unsorted municipal waste when discarding. Each material must be separated. The symbol will be placed near the AC receptacle, except for portable equipment where it will be placed on the battery lid.

The symbol appears as such:



# Section 10

## Parts List

	<u>Reference</u>	<u>Description</u>	<u>Part Number</u>
<b>Model 2241-3 Survey Meter</b>	UNIT	Completely Assembled Model 2241-3 Survey Meter	48-2864
<b>Main Circuit Board, Drawing 408 × 226</b>	BOARD	Completely Assembled Main Circuit Board	5408-226
CAPACITORS	C1	0.1 $\mu$ F, 50V	04-5663
	C3	0.1 $\mu$ F, 50V	04-5663
	C001-C002	47pF, 100V	04-5660
	C011	0.001 $\mu$ F, 100V	04-5659
	C012	0.1 $\mu$ F, 50V	04-5663
	C021	100pF, 3KV	04-5532
	C031	0.0047 $\mu$ F, 3KV	04-5547
	C032	100pF, 3KV	04-5532
	C033	0.0047 $\mu$ F, 3KV	04-5547
	C041-C043	0.0047 $\mu$ F, 3KV	04-5547
	C101	47 $\mu$ F, 10V	04-5666
	C121	47 $\mu$ F, 10V	04-5666
	C122-C123	27pF, 100V	04-5658
	C131	0.0047 $\mu$ F, 3KV	04-5547
	C132-C133	0.1 $\mu$ F, 50V	04-5663
	C134	0.01 $\mu$ F, 50V	04-5664
	C135	47 $\mu$ F, 10V	04-5666
	C136	0.01 $\mu$ F, 50V	04-5664
	C137	47 $\mu$ F, 10V	04-5666
	C138	100pF, 100V	04-5661
	C139	0.001 $\mu$ F, 100V	04-5659
	C141	0.0047F, 3KV	04-5547



	<u>Reference</u>	<u>Description</u>	<u>Part Number</u>
	C241	1 $\mu$ F, 35V	04-5656
	C242	68 $\mu$ F, 10V	04-5654
	C243	0.1 $\mu$ F, 50V	04-5663
	C251	68 $\mu$ F, 10V	04-5654
TRANSISTORS	Q101	2N7002L	05-5840
	Q141	MMBT3904LT1	05-5841
	Q211	2N7002L	05-5840
	Q212	MMBT4403LT1	05-5842
	Q241	MJD210 RL	05-5843
INTEGRATED CIRCUITS	U1	MAX810LEUR	06-6424
	U001	CD74HC4538M	06-6297
	U011	TLC372ID	06-6290
	U021	CA3096M; 16=GND	06-6288
	U111	AT89C51RC2	06-6893
	U121	LM285MX-2.5	06-6291
	U122	X24C02S8T5	06-6299
	U131	LM358D	06-6312
	U231	LT1073CS8-5	05-5852
DIODES	CR021	MMBD7000LT1	07-6355
	CR031	GI250-2	07-6266
	CR041-CR044	GI250-2	07-6266
	CR231	CXSH-4 EB33	07-6358
	CR241	MMBD914LT1	07-6353
	CR242	CXSH-4 EB33	07-6358
POTENTIOMETERS / TRIMMERS	R002	10K; 3269X1-103, VOLUME	09-6921
	R027	1M; 3269X1-105, HV LIMIT	09-6906
RESISTORS	R001	100K, 1/4W, 1%	12-7834
	R011-R012	10K, 1/4 W, 1%	12-7839
	R013	1K, 1/4W, 1%	12-7832
	R014	10K, 1/4W, 1%	12-7839
	R015	100K, 1/4W, 1%	12-7834
	R021	1M, 1/4W, 5%	10-7028
	R022	392K, 1/8W, 1%	12-7841
	R023	10K, 1/4W, 1%	12-7839
	R024-R025	4.75K, 1/4W, 1%	12-7858

	<u>Reference</u>	<u>Description</u>	<u>Part Number</u>
	R026	8.25K, 1/8W, 1%	12-7838
	R031	4.75M, 1/4W, 5%	10-7030
	R032	1M, 1/4W, 5%	10-7028
	R033-R034	1G, FHV-1, 2%	12-7686
	R111-R113	22.1K, 1/4W, 1%	12-7843
	R121	100Ohm, 1/4W, 1%	12-7840
	R122	6.81K, 1/4W, 1%	12-7857
	R131	1M, 1/4W, 1%	12-7844
	R132	511K, 1/8W, 1%	12-7896
	R133	750K, 1/4W, 1%	12-7882
	R134	1M, 1/4W, 1%	12-7844
	R135	82.5K, 1/8W, 1%	12-7849
	R136	10K, 1/4W, 1%	12-7839
	R141	22.1K, 1/4W, 1%	12-7843
	R211	2.21K, 1/4W, 1%	12-7835
	R231	100Ohm, 1/4W, 1%	12-7840
	R241	2.21K, 1/4W, 1%	12-7835
	R242	200Ohm, 1/8W, 1%	12-7846
CRYSTALS	Y221	6.144 MHZ, 2=GND, 3=GND	01-5262
INDUCTOR	L231	100uH, CTX100-2	21-9740
TRANSFORMERS	T101	4275-083, AUDIO	4275-083
	T141	L8050	40-0902
MISCELLANEOUS	P1-P2	1-640456-3, MTA100X13	13-8100
	P3	640456-6, MTA100X6	13-8095
	P4	640456-2, MTA100X2	13-8073
	P5	1-640456-2, MTA100X12	13-8061
<b>Calibration Board, Drawing 408 x 98</b>	BOARD	Completely Assembled Calibration Board	5408-113
POTENTIOMETERS	R115	1M, HV1 SET	09-6814
	R116	100K, DISC.	09-6813
	R117	1M, HV2 SET	09-6814
	R118	1M, HV3 SET	09-6814
	R119	1M, HV4 SET	09-6814

	<u>Reference</u>	<u>Description</u>	<u>Part Number</u>
RESISTORS	R110	1M, 1/3W	12-7751
	R111	10K, 1/3W	12-7748
	R112	1M, 1/3W	12-7751
	R113	1K, 1/3W	12-7750
	R114	1M, 1/3W	12-7751
	R120	1M, 1/3W	12-7751
CONNECTOR	P7	CONN-640456-7, MTA100	13-8115
<b>Display Board, Drawing 408 × 259</b>	BOARD	Completely Assembled Display Board	5408-259
CAPACITORS	C1	27pF, 100V	04-5658
INTEGRATED CIRCUITS	U1	AY0438-I/L	06-6358
	U2	AY0438-I/L	06-6358
RESISTORS	R001-R004	10.0K, 1%, 125mW	12-7839
	R005	392 Ohm, 1%, 1/8 W	12-7054
MISCELLANEOUS	J1	CONN-640456-8, MTA100	13-8039
	DS1	EL-BACKLIGHT-LED	07-6527
	DSP1	MAIN DISPLAY; LCD-8246-365-4E1-A/W-REV1	07-6383

	<u>Reference</u>	<u>Description</u>	<u>Part Number</u>
<b>Switch Board, Drawing 408 × 45</b>	BOARD	Completely Assembled Switch Board	5408-052
CAPACITORS	C1-C2	4.7μF, 10V	04-5578
	C3-C4	10μF, 20V	04-5592
	C5	4.7μF, 10V	04-5578
	C6	100μF, 10V	04-5576
INTEGRATED CIRCUITS	U1	MAX220EPE	06-6359
SWITCHES	S1	350134GSK; FUNCTION; 16 POS	08-6721
	S2	LEFT	08-6716
	S3	UP	08-6716
	S4	ENTER	08-6716
RESISTORS	R1-R2	22K	10-7070
MISCELLANEOUS	P6	CONN-1-640456-3, MTA100	13-8100
	P10	CONN-208006-2	13-8451
<b>Chassis Wiring Diagram, Drawing 408 × 101</b>			
SWITCHES	S1	30-1-PB GRAYHILL	08-6517
	S2	PA-1012	08-6540
	S3-S4	7101-SYZ-QE C&K	08-6511
	S5	30-1-PB GRAYHILL	08-6517
	S6	7201KZQE Toggle	08-6749
	S7	MPS-103F	08-6699
	*	Switch Cap	08-6871
RESISTOR	R1	10 M, 1/4W, 5%	10-7031
CONNECTORS	J1 J2	CONN-1-640442-3, MTA100	13-8138
	J3	CONN-640442-6, MTA100	13-8171
	J4	CONN-640442-2, MTA100	13-8178
	J5	CONN-1-640442-2, MTA100	13-8407
	J6	CONN-1-640442-3, MTA100	13-8138
	J7	CONN-640442-7, MTA100	13-8172
	J8	CONN-640442-8, MTA100	13-8184
	J9	Series "C" -UG706/U	13-7777
	J10	JACK-09-9011-1-4193	18-9080
	P10	Handle Pin	7408-055

	<u>Reference</u>	<u>Description</u>	<u>Part Number</u>
AUDIO	DS1	UNIMORPH	21-9251
BATTERY	B1-B2	"D" Duracell Battery	21-9313
MISCELLANEOUS	*	Model 2241 Switch Board Add On	4408-053
	*	Model 2241 Digital Bezel Assembly	4408-051
	*	Portable Battery Contact Set	2001-042
	*	Model 2241-3 Main Harness	8408-121
	*	Portable Harness Can Wires	8363-462
	*	Switch Board Harness	8408-027
	*	Portable Can Assembly (MTA)	4363-441
	*	Can Gasket	22-9773
	*	Portable Knob	08-6613
	*	Assembled Battery Lid	2363-191
	*	Portable Battery Gasket	7363-183
	*	Portable Calibration Cover with Screws	9363-200
	*	Model 2241-3 Flat Handle Assembly without Clip	4408-179
	*	Cable-C 39 inch only	40-1004
	*	Model 2241-3 Casting	7408-185
	*	SOURCE – <sup>137</sup> CS 37 kBq; 1 μCi <sup>137</sup> CS (Check Source)	01-5196
	*	SOURCE HOLDER	4062-166
	*	CARRYING CASE	2313065
<b>Model 44-9 Alpha-Beta-Gamma Detector (PANCAKE)</b>	UNIT	Completely Assembled Model 44-9 Alpha-Beta-Gamma Detector	47-1539
	*	DETECTOR BODY	2002-109
	*	HANDLE GRIP	7002-426
	*	G-M TUBE (LND 7311) TGM N1002	01-5008
	*	SOCKET SET SCREWS (10-34 X 1/4), 3 EACH	17-8560

	<u>Reference</u>	<u>Description</u>	<u>Part Number</u>
	*	PENCIL CLIP	01-5237
	*	RESISTOR, 3.3 MEGOHMS	10-7044
	*	CONNECTOR, UG 706/U	13-7751
	*	HV WIRE	21-9312
	*	PROTECTIVE SCREEN	21-9586
	*	RED PROTECTIVE CAP	03-5476
<b>Model 44-2 Gamma Scintillator</b>	UNIT	Completely Assembled Model 44-2 Gamma Scintillator	47-1532
	*	DETECTOR BODY	2002-084-01
	*	END CAP	7002-029-02
	*	2.5 x 2.5 cm (1 x 1 in.) NaI CRYSTAL	40-5154
	*	3.8 cm (1.5 in.) TUBE/SOCKET ASSY.	4002-510
	*	TUBE SHIELD	40-4006
	*	PM TUBE	01-5742
	*	CONNECTOR UG 706/U	13-7751
	*	TEFLON WIRE 4 ea.	21-9362
	*	#26 BLACK WIRE 4 ea.	21-9558
	*	LUG	18-8766
	*	SCREWS 4 ea.	17-8811
	*	SPONGE 6 ea.	7002-029-05
	*	XTAL SIDE SPONGE 2 ea.	7002-276
	BOARD	Completely Assembled Tube Socket Circuit Board Included in PM TUBE 01-5742	5002-502
<b>Model 133-7 GM Detector</b>	UNIT	Completely Assembled Model 133-7 GM Detector	47-1216
	*	GM TUBE (CSF 3G70)	01-5045
	*	RES- 2.2 MEG, 1/4W, 5%	10-7052
	*	Model 133 BODY	7002-328
	*	Model 133 END CAP	7002-322
	*	Model 133 CAP	7002-020-01
	*	CONNECTOR SERIES "C"	4478-011
	*	TUBE SHIELD	01-5055

**Section**  
**11**

## **Drawings**

---

Main Circuit Board, Drawings 408 × 226 (3 sheets)

Main Circuit Board Component Layout, Drawing 408 × 227

Calibration Board, Drawing 408 × 98

Calibration Board Component Layout, Drawings 408 × 99 (2 sheets)

Display Board, Drawing 408 × 259

Display Board Component Layout, Drawings 408 × 260 (2 sheets)

Switch Board, Drawing 408 × 45

Switch Board Component Layout, Drawing 408 × 46

Wiring Diagram, Drawing 408 × 101

Model 44-9 Alpha, Beta, Gamma Detector, Drawing 2 x 206

Gamma Energy Response for Ludlum Model 44-9

Beta Source Efficiencies for Model 44-9

Model 44-2 Gamma Scintillator Assembly View, Drawing 2 x 205A

3.8 cm (1.5 in.) Tube Socket Board, Drawing 2 x 317

3.8 cm (1.5 in.) Tube Socket Board Component Layout,  
Drawing 2 x 318

Gamma Energy Response Curve Model 44-2

Model 133-7 Probe Assembly, Drawing 2 x 634



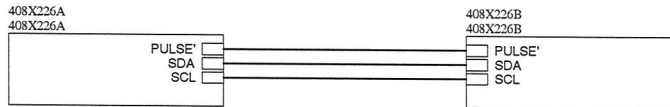

		<b>LUDLUM</b>		PO Box 810	
		<b>MEASUREMENTS, INC.</b>		501 Oak Street	
				Sweetwater, Texas 79556	
				U.S.A. 1-800-622-0828	
Drawn:	SA	01/19/05	Title:	MAIN BOARD	
Design:	RSS	01/04/05	Model:	2241-3	
Approve:	<i>RSS</i>	<i>17 Jan 05</i>	Board#:	5408-226	
14:13:35		19-Jan-2005	Sheet:	1 of 3	
408226			Rev:	1.0	
			Series	408	Sheet
					226

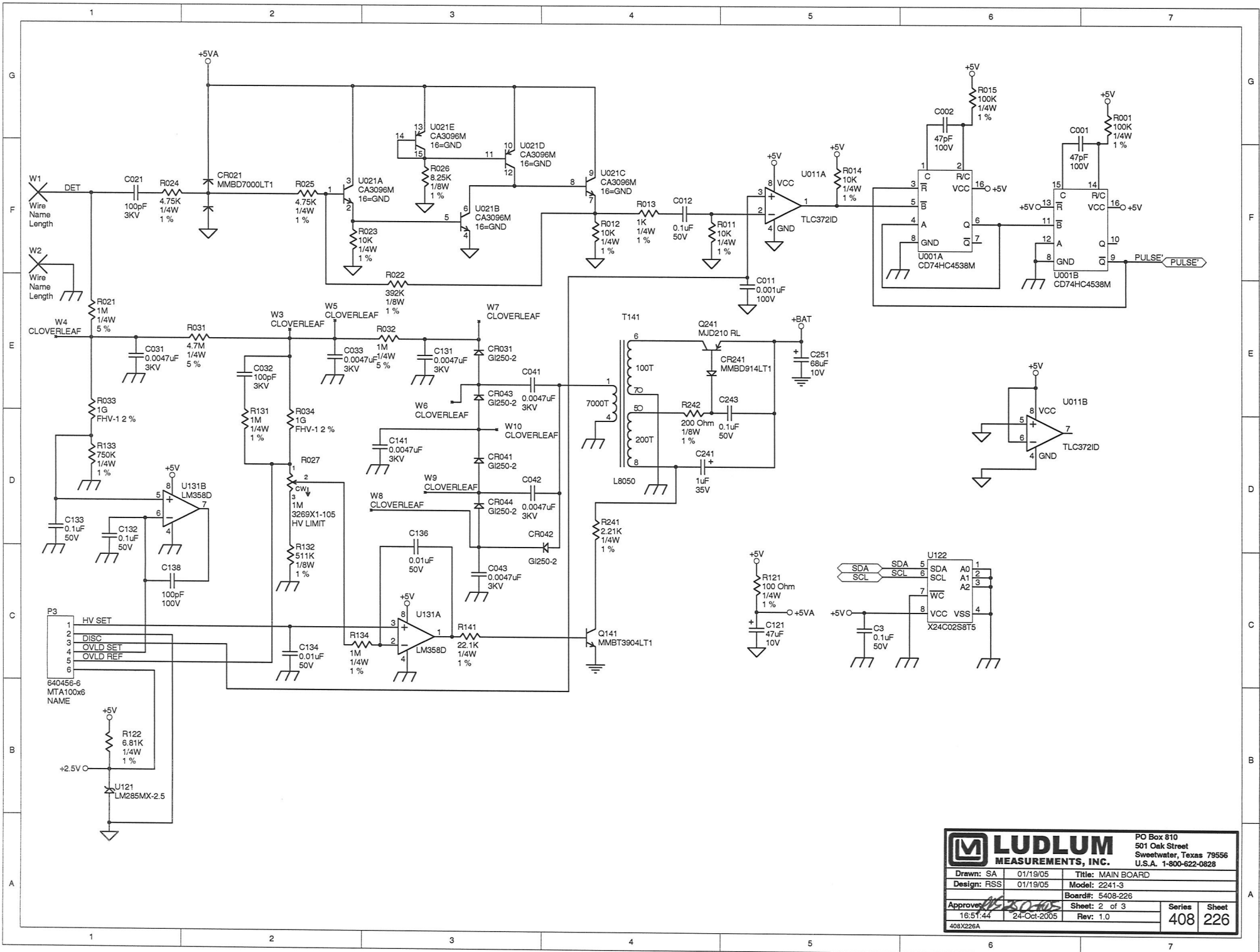

**LUDLUM MEASUREMENTS, INC.** PO Box 810  
501 Oak Street  
Sweetwater, Texas 79556  
U.S.A. 1-800-622-0828

Drawn: SA	01/19/05	Title: MAIN BOARD
Design: RSS	01/19/05	Model: 2241-3
Approved: <i>[Signature]</i>	24-Oct-2005	Board#: 5408-226
16:51:44		Sheet: 2 of 3
408X226A		Rev: 1.0

Series 408 Sheet 226

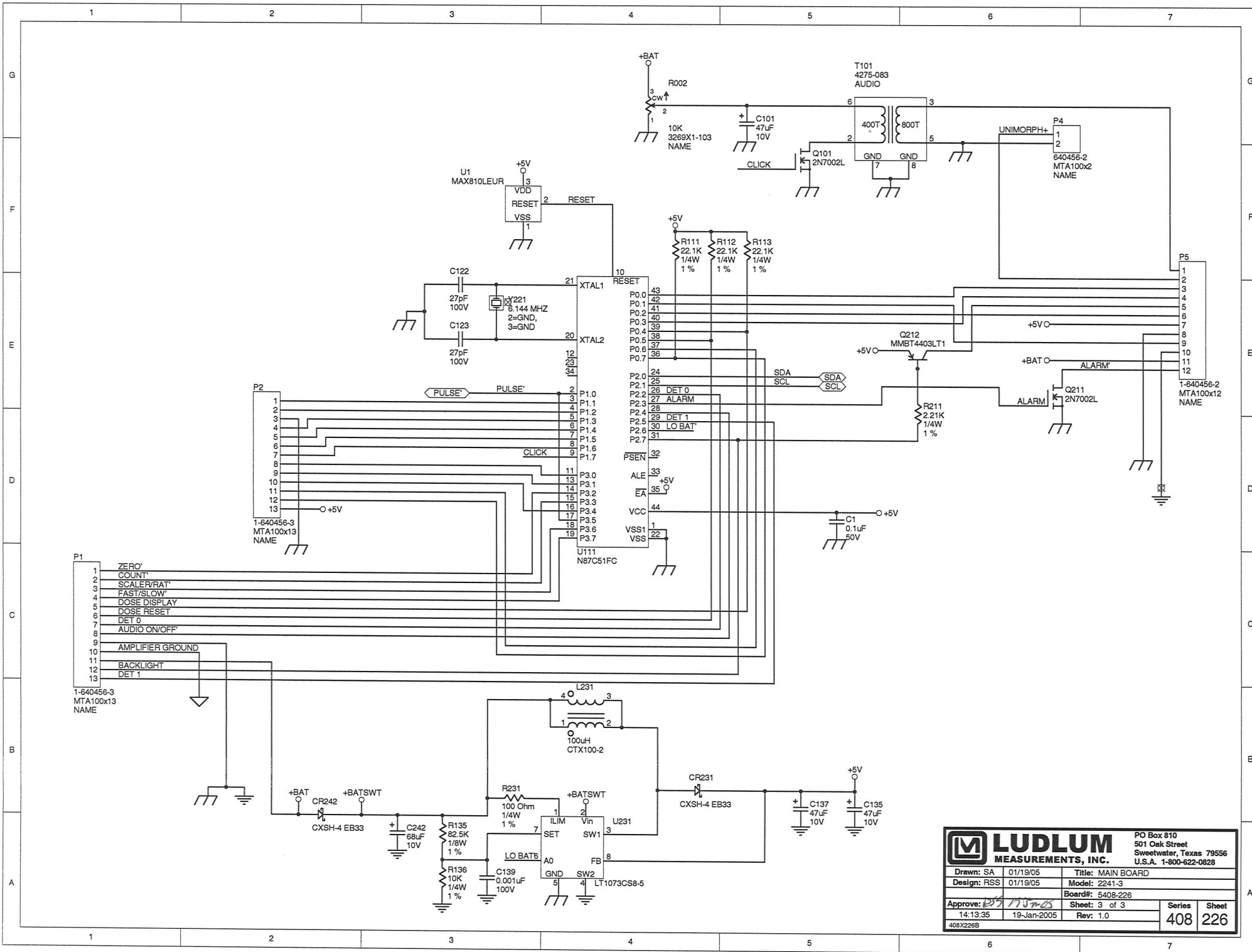

		PO Box 810 501 Oak Street Sweetwater, Texas 79556 U.S.A. 1-800-622-0828	
		Drawn: SA 01/19/05 Design: RSS 01/19/05	Title: MAIN BOARD Model: 2241-3 Board#: 5408-226
Approve: <i>[Signature]</i> 14:13:35 19-Jan-2005	Sheet: 3 of 3 Rev: 1.0	Series <b>408</b>	Sheet <b>226</b>

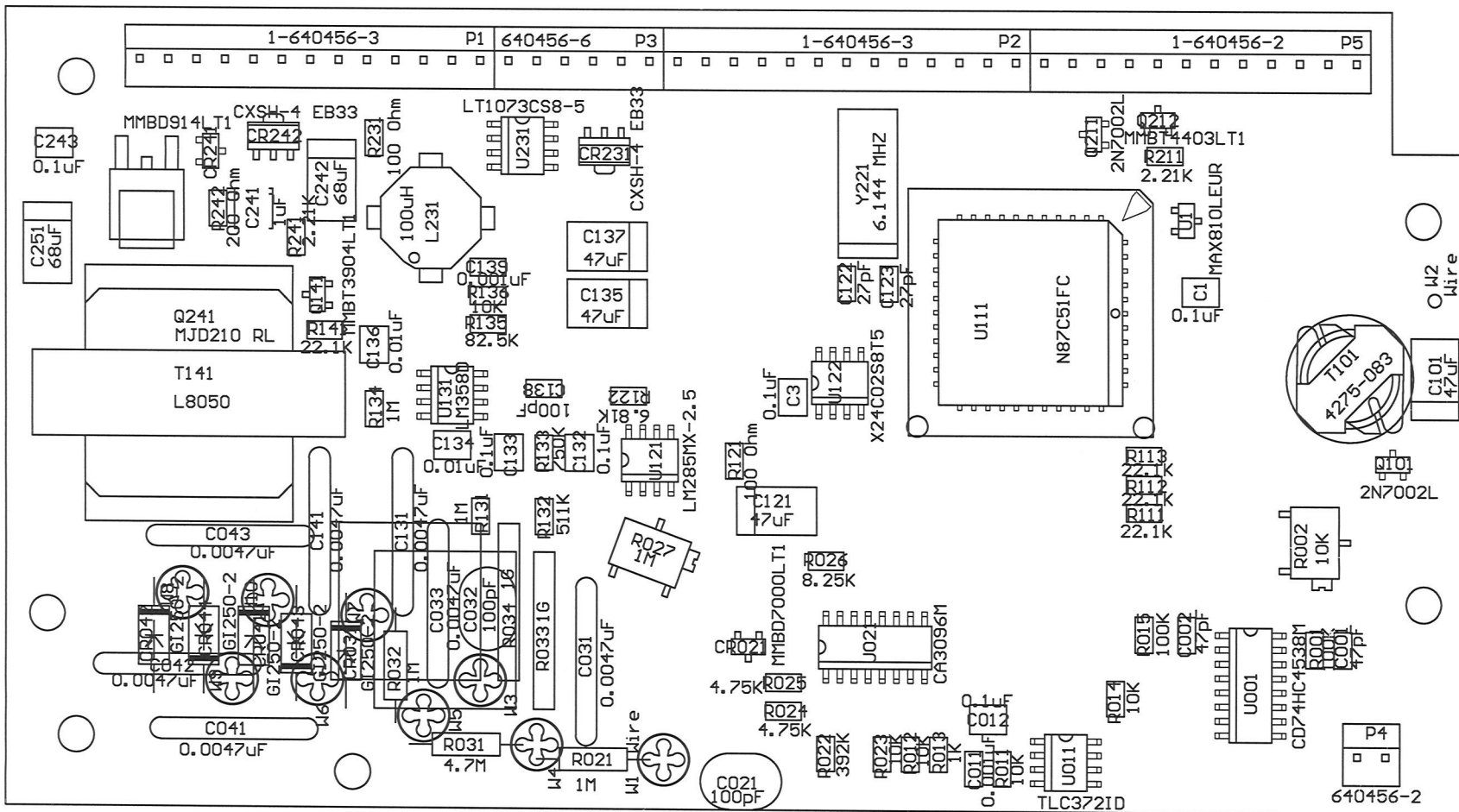

Drawn:	SA	01/19/05	Title:		
Design:	RSS	01/19/05	MAIN BOARD		
Approve:	<i>RSS</i>	<i>27 May 05</i>	Model: 2241-3		
Layer:			Board#: 5408-226		
Mech.1	MID:	11:23:14	Rev: 1.0		Series
Mech.2			SCALE: 1.71		408
BS408226			Sheet 227		

REVISIONS			
EFF	AUTHORITY	ZONE / LTR	DESCRIPTION

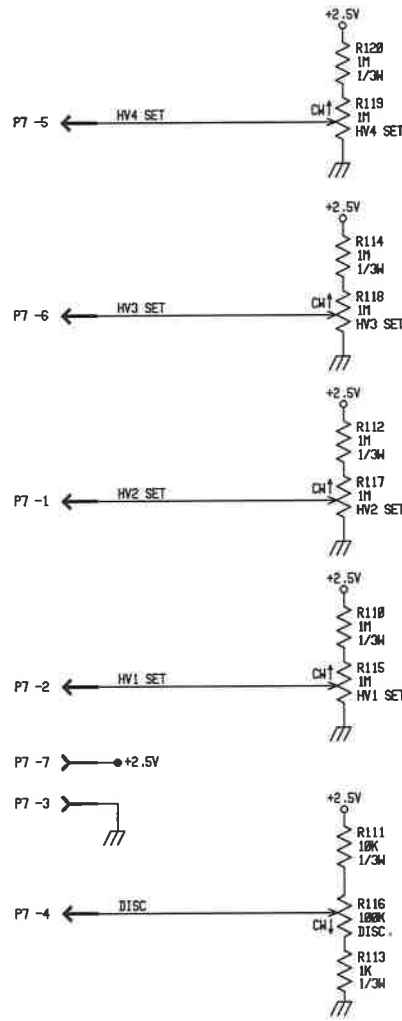

UPDATED		LUDLUM MEASUREMENTS INC.			
DR	CKB	09/24/96	TITLE : CALIBRATION BOARD		
CHK	CSH	6-13-97	BOARD# 5488-113		
DSCN	RSS	09/24/96	SIZE	MODEL	SERIES
APPD	RDS	230412	C	2241-3	488
NEXT HIGHER ASSY.					SHEET
15748-11	19-May-97	S8488-113			98
					OF 1

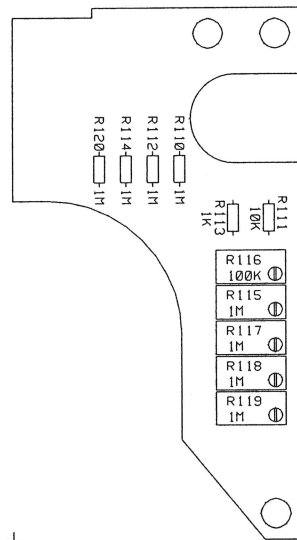

DISCRIMINATOR  
 HV1 SET  
 HV2 SET  
 HV3 SET  
 HV4 SET

+

LUDLUM MEASUREMENTS INC. SHEETWATER, TX.			
DR	CKB	09/24/96	TITLE: CALIBRATION BOARD
		BOARD: 5408-113	
DSCN	RSS	09/24/96	MODEL: 2241-3
APP	<i>AP</i>		FILENAME: BS408113
COMPONENT	SOLDER	15:11:35	23-May-04
OUTLINE	OUTLINE	1.0	408 99

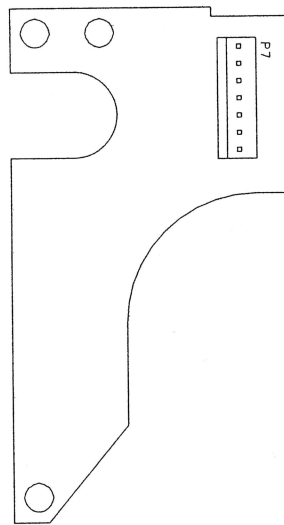

 LUDLUM MEASUREMENTS INC. SWEETWATER, TX.			
DR	CKB	09/24/96	TITLE: CALIBRATION BOARD
		BOARD# 5408-113	
DSCN	RSS	09/24/96	MODEL 2241-3   SERIES 408   SHEET 99
APP	<i>W. J. D. W.</i>		COMP ARTWORK <input type="checkbox"/>   SLDRT ARTWORK <input type="checkbox"/>
		COMP OUTLINE <input type="checkbox"/>   SLDRT OUTLINE <input checked="" type="checkbox"/>	
		COMP PASTE <input type="checkbox"/>   COMP MASK <input type="checkbox"/>   SLDRT PASTE <input type="checkbox"/>   SLDRT MASK <input type="checkbox"/>	

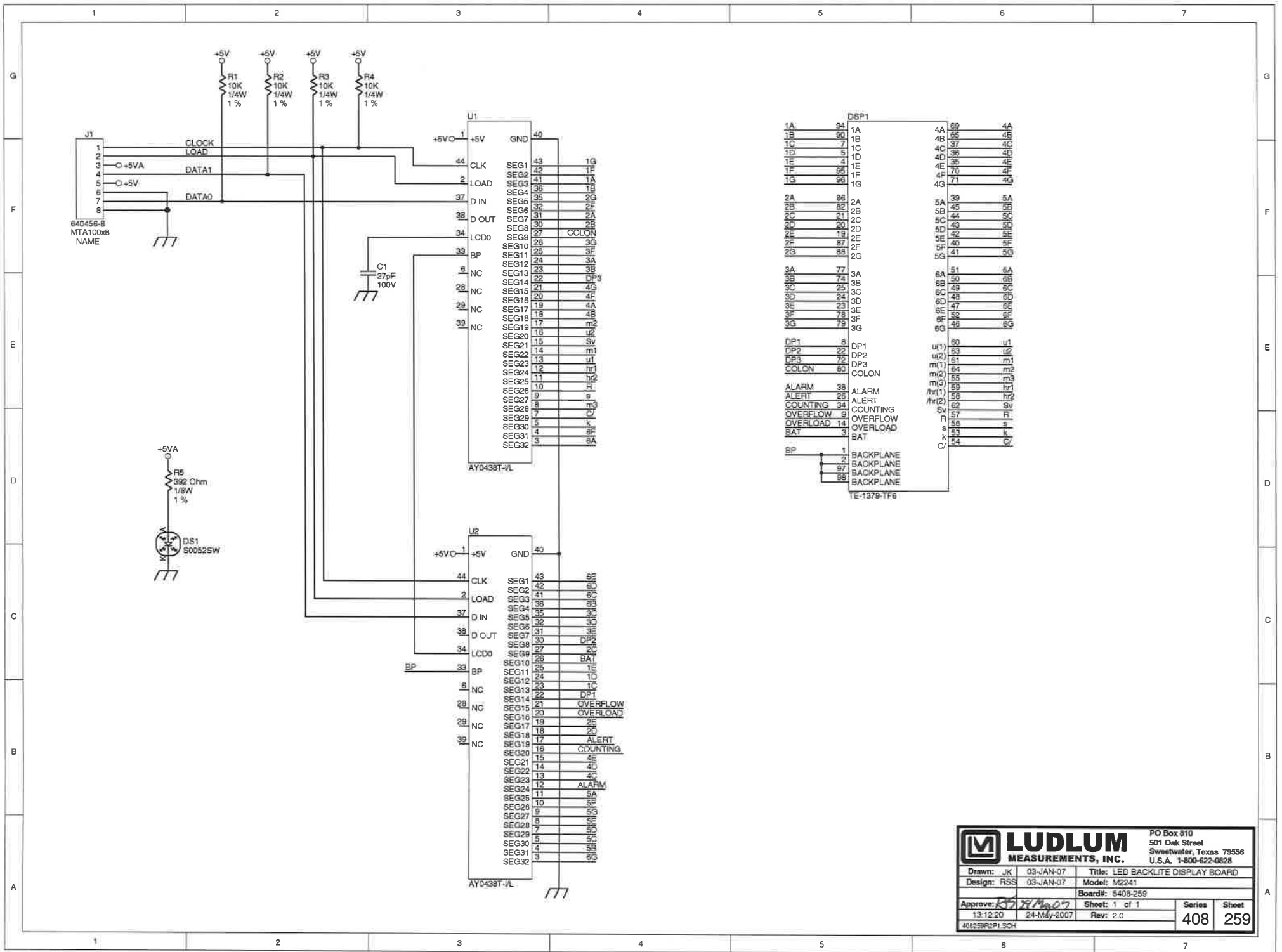

		PO Box 810 501 Oak Street Sweetwater, Texas 79556 U.S.A. 1-800-622-0828			
		Drawn: JK Design: RSS	03-JAN-07 03-JAN-07	Title: LED BACKLITE DISPLAY BOARD Model: M2241	Board: 5408-259
Approve: <i>RJ</i>	13:12:20	24-May-2007	Sheet: 1 of 1 Rev: 2.0	Series <b>408</b>	Sheet <b>259</b>
408259R2P1.SCH					



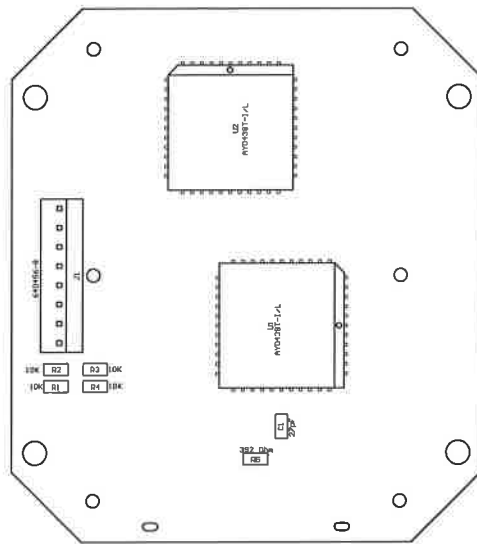

Drawn:	JK	23-FEB-07	Title:		
Design:	RSS	23-FEB-07	LED BACKLITE DISPLAY BOARD		
			Model: M2241		
Approve:	<i>RSS</i>	<i>24/2/07</i>	Board#: 5408-259		
Layer:			Rev: 2.0	Series	Sheet
	MID: 13:15:16		SCALE: 1.00	408	260
408259R2X1.PCB					

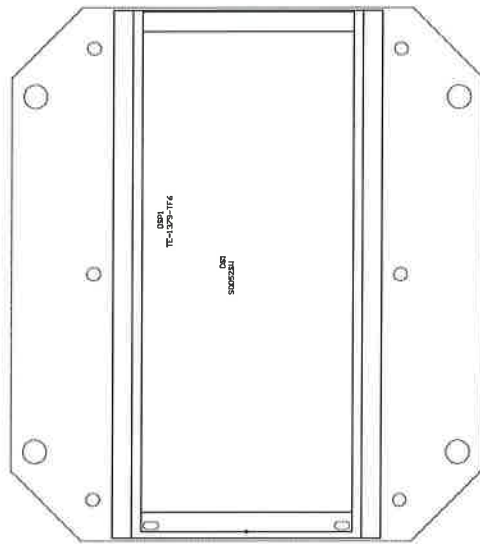

Drawn: JK	23-FEB-07	Title: LED BACKLITE DISPLAY BOARD	
Design: RSS	23-FEB-07	Model: M2241	
Approve: <i>RH</i>	<i>24/May/07</i>	Board#: 5408-259	
Layer:		Rev. 2.0	Series Sheet
	MID:	SCALE: 1.00	408 260
	13:15:16 24-May-2007		
408259R2X1.PCB			

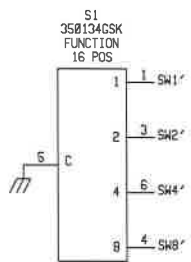
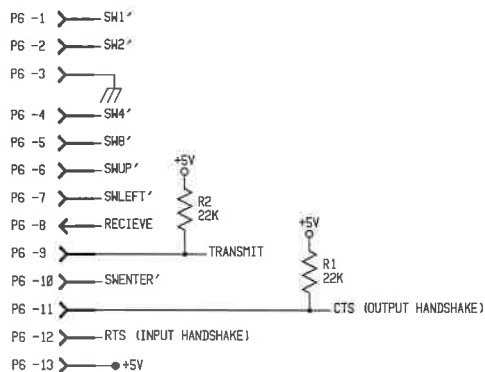

POS	FUNCTION
0	NORMAL OPERATION
1	DEAD TIME (us)
2	CALIBRATION CONSTANT
3	DISPLAY UNITS
4	TIMEBASE: CPS, CPM
5	AUDIO DIVIDE BY
6	RESPONSE TIME
7	RATEMETER ALARM / ALERT
8	SCALER ALARM / COUNT TIME
9	NOT USED
A	DETECTOR SETUP NUMBER
B	LCD BACKLIGHT ON TIME
C	SET MINIMUM DISPLAY
D	RS-232 DATA DUMP MODE
E	RS-232 DETECTOR SETUP MODE
F	RS-232 BAUD RATE

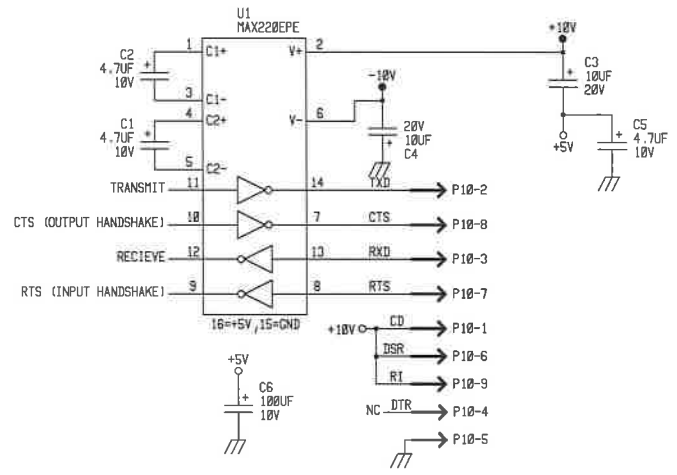
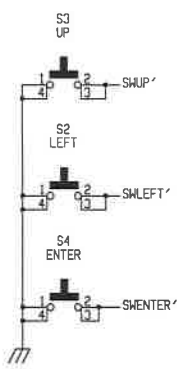

UPDATED	CKB	21-DEC-88	LUDLUM MEASUREMENTS INC.			
DR	CKB	06/24/96	TITLE: SWITCH BOARD			
CHK	RSS	11-11-00	BOARD# 5408-052			
DSGN	LL	3/17/93	SIZE	MODEL	SERIES	SHEET
APPD	RPS	21-Dec-88	C	2241	488	45
NEXT HIGHER ASSY.			SHEET 1 OF 1			
09:54:25		21-Dec-88	58400852			

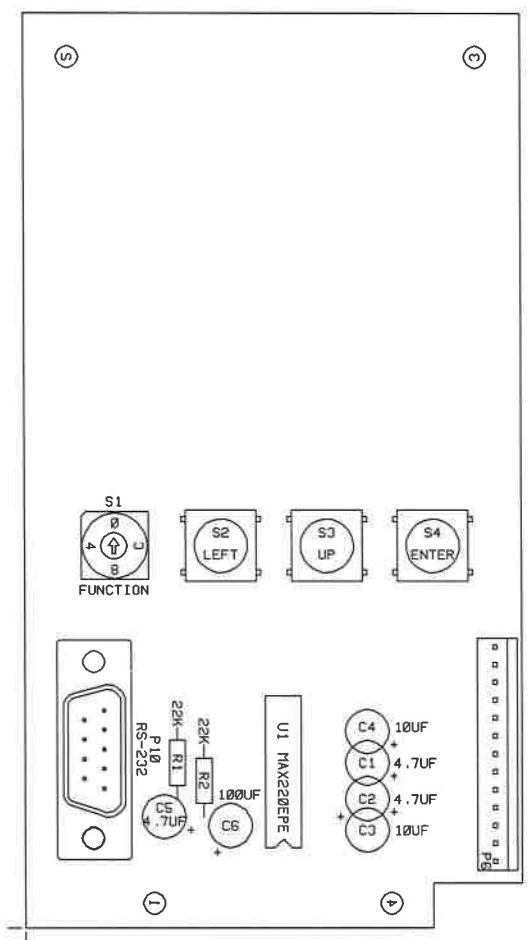

<b>LUDLUM MEASUREMENTS INC.</b> , SHEETWATER, TX.				
DR	CKB	06/24/96	TITLE: SWITCH BOARD	
CHK	BS	12-11-00	BOARD: 5408-052	
DSCN	LL	03/16/94	MODEL: 2241	
APP	RS	21 Dec 00	FILENAME: BS408052	
COMPONENT	SOLDER	09:52:54	21-Dec-00	
OUTLINE	OUTLINE	1.0	408	46

REVISIONS				
EFF	AUTHORITY	ZONE	DATE	APPROVED

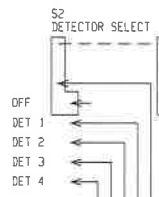
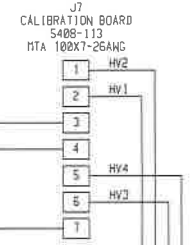
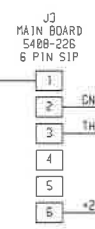
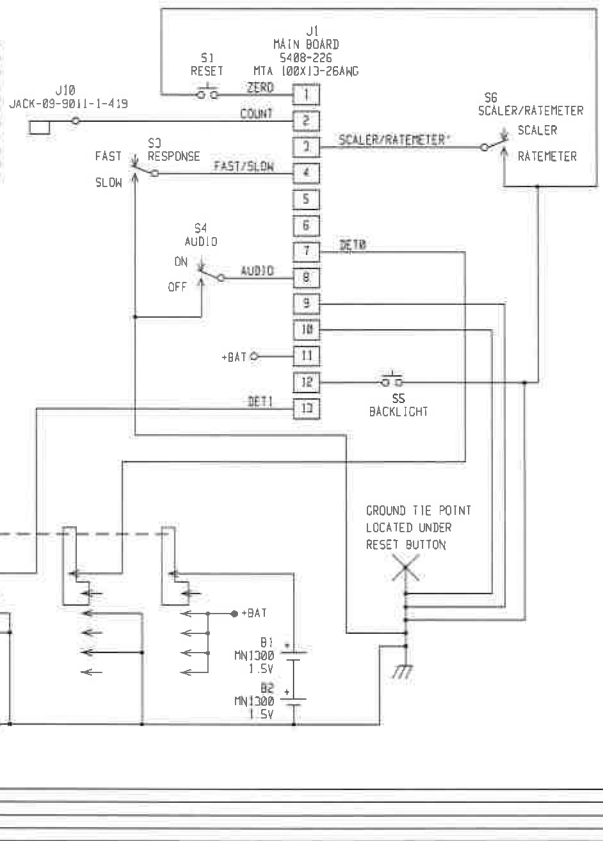
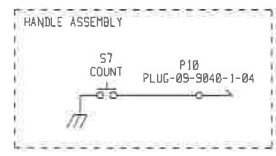
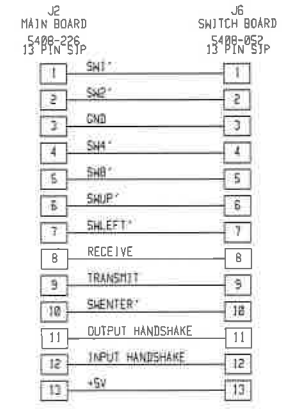
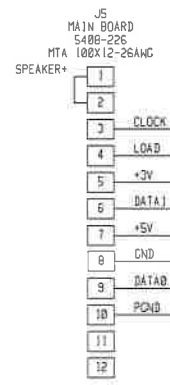
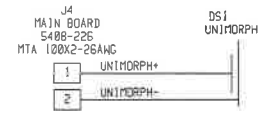

UPDATED	SA	03-29-01	LUDLUM MEASUREMENTS INC.		
DR PW		11/11/96	TITLE : WIRING DIAGRAM		
DSCN RSS		11/11/96	BOARD#	408-114	
APPD		24/07	SIZE	MODEL	SERIES
NEXT HIGHER ASSY			C	2241-3	408
16-33-13		29-Mar-87	W48814		SHEET 101

REVISION HISTORY			
REV	DESCRIPTION	DATE	BY
1	VALID	3/23/2007	CMC
2	ADDED BLACK SHRINK	1-26-10	RHS
3	ECF 3861	12-9-2016	ACK

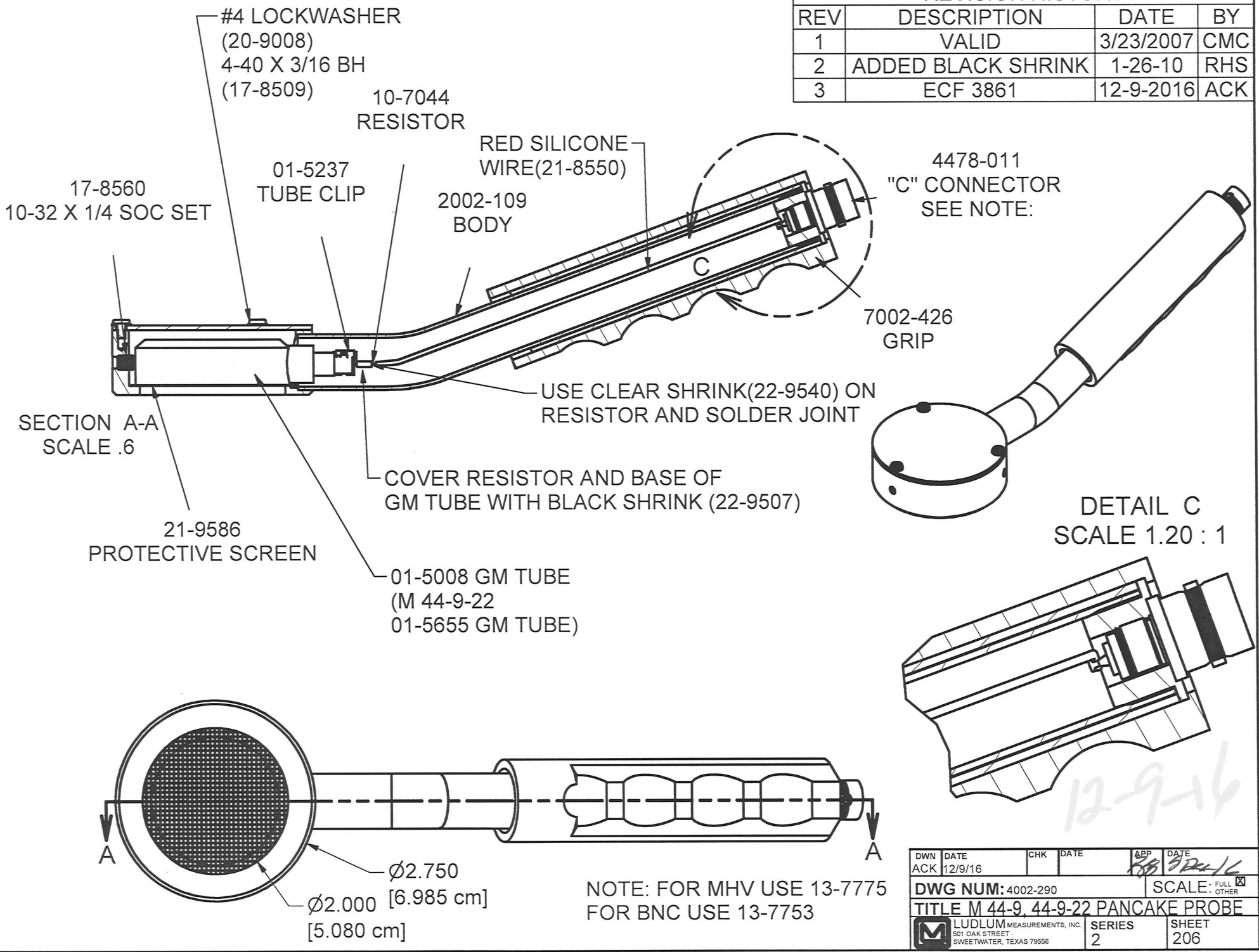

DWN	DATE	CHK	DATE	APP	DATE
ACK	12/9/16			<i>RHS</i>	12/9/16
DWG NUM: 4002-290					SCALE: FULL <input checked="" type="checkbox"/> OTHER
TITLE M 44-9, 44-9-22 PANCAKE PROBE					
LUDLUM MEASUREMENTS, INC. 501 OAK STREET SWEETWATER, TEXAS 79556				SERIES	SHEET
				2	206

### Energy Response for Ludlum Model 44-9

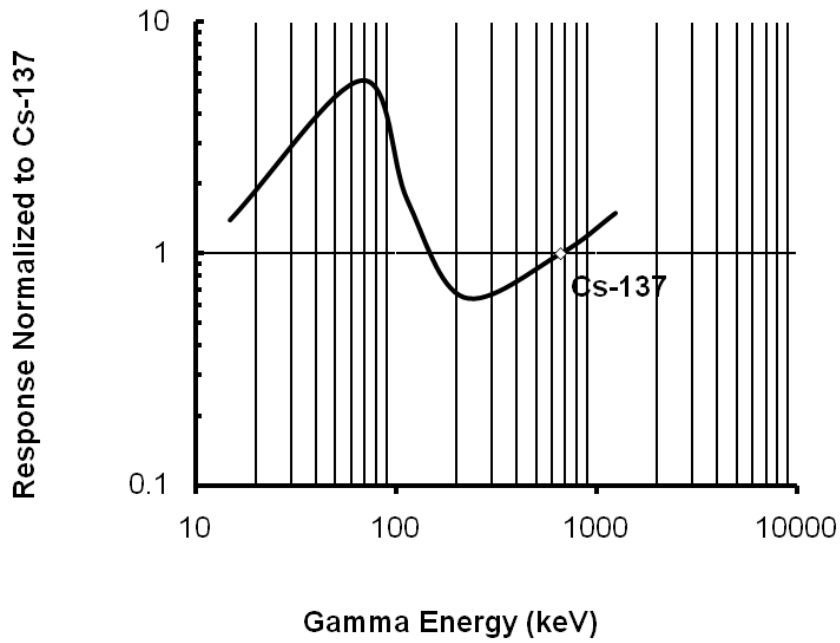

### Model 44-9 4pi Beta Efficiency

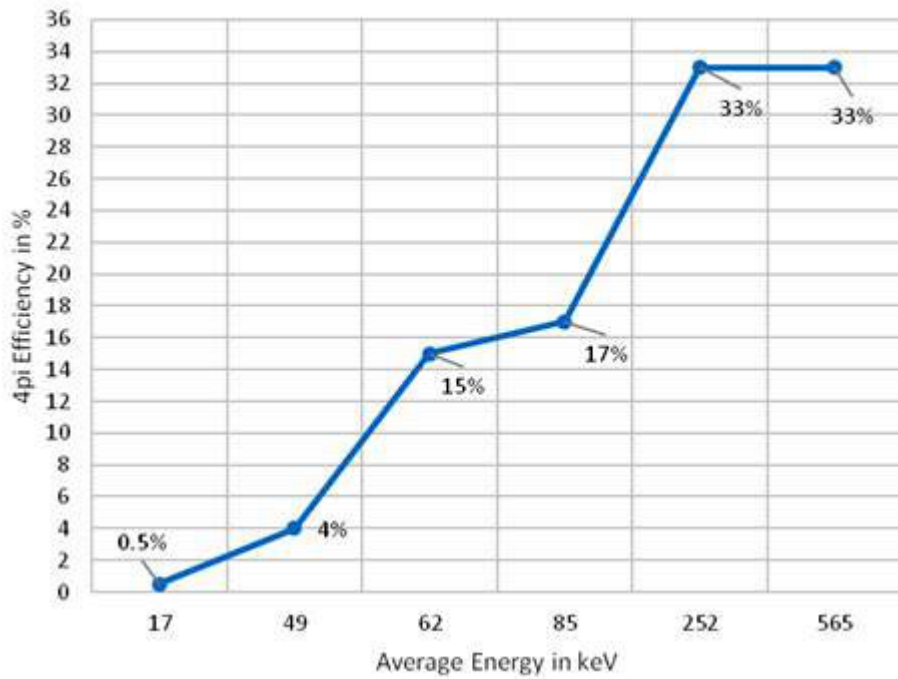

REV #	ALTERATIONS	DATE	BY
1	VALID	---	---
2	CHANGED 4002-510 TO A 01-5742	5-22-03	JSM
3	ECF# 1,609	11/25/03	CLW

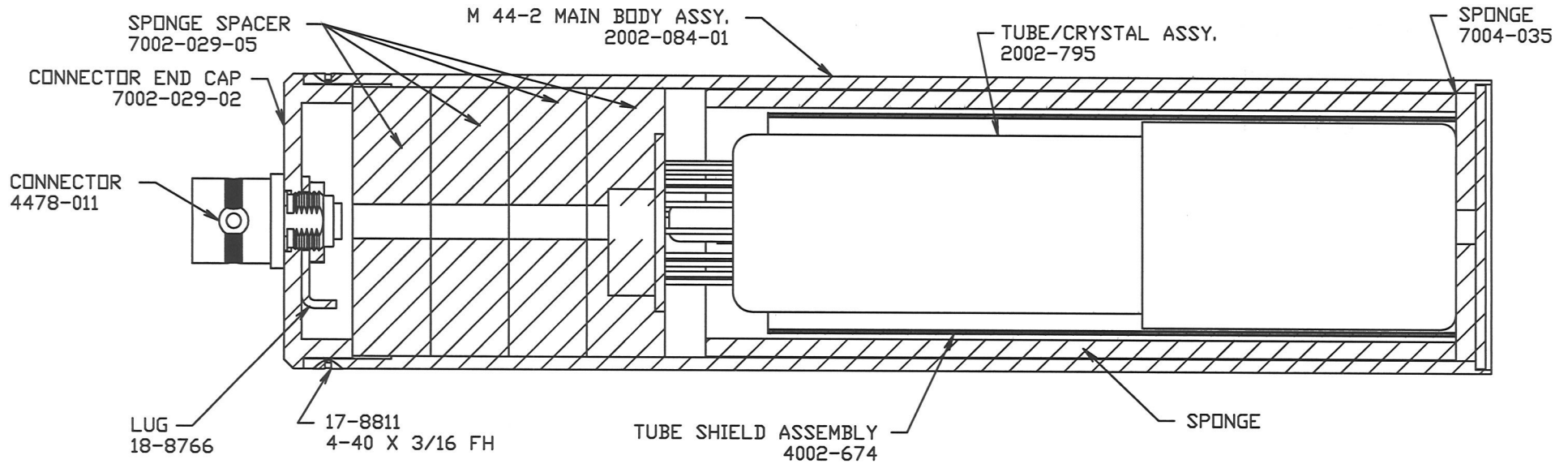



DWN	DATE	CHK	DATE	APP	DATE
CLW	11/24/03			J40	12-2-03
DWG NUM:	4002-289	SCALE:	FULL	OTHER	3/4
TITLE M-44-2 ASSEMBLY DRAWING					
LUDLUM MEASUREMENTS, INC. 501 DAK STREET SWEETWATER, TEXAS 79556				SERIES	SHEET
				2	205A

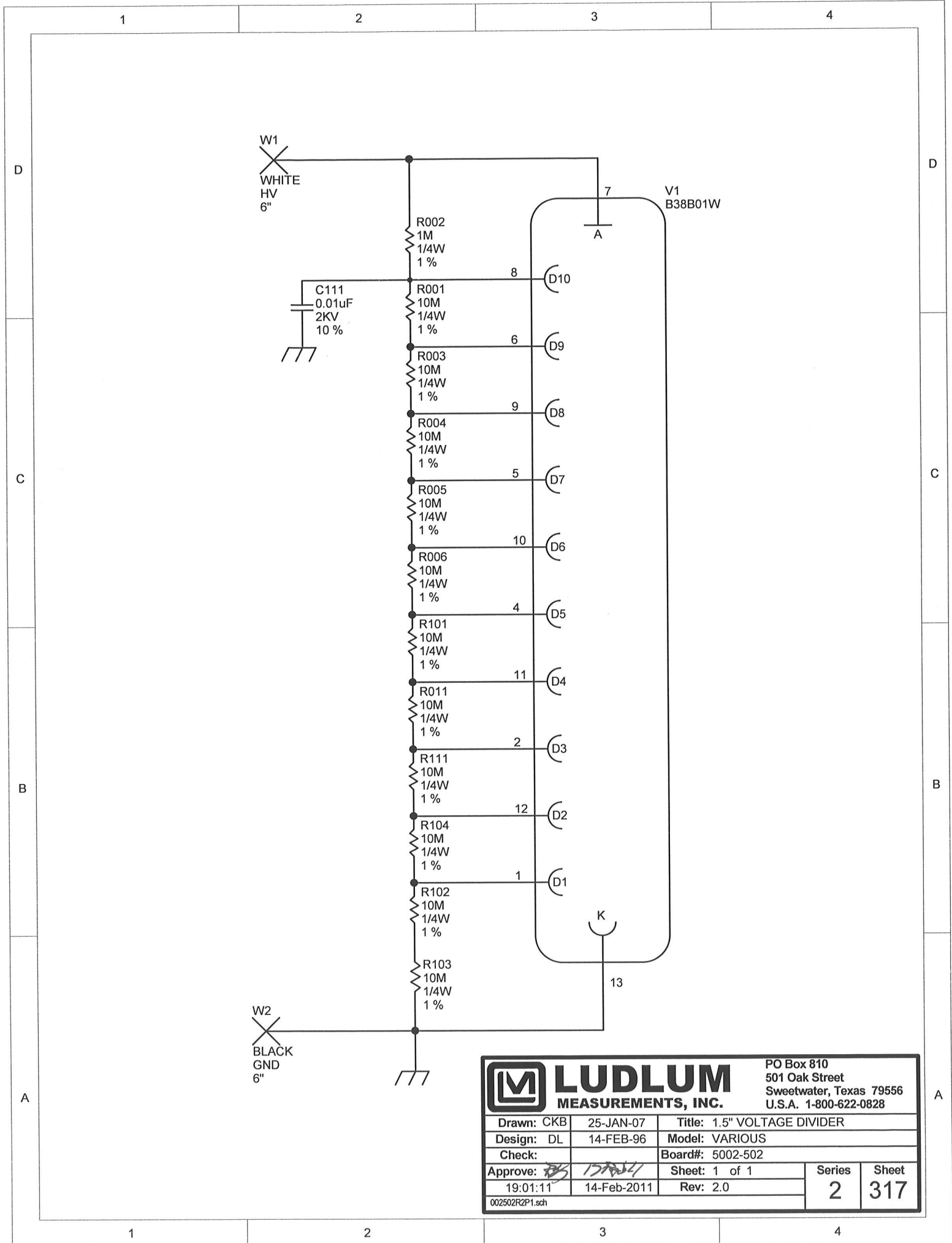

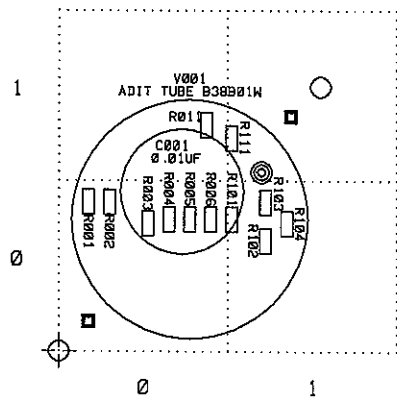

		PO Box 810 501 Oak Street Sweetwater, Texas 79556 U.S.A. 1-800-622-0828	
		<b>Drawn:</b> CKB <b>Design:</b> DL <b>Check:</b>	<b>25-JAN-07</b> <b>14-FEB-96</b>
<b>Approve:</b> <i>BS</i> <i>12/24/11</i> 19:01:11 002502R2P1.sch	<b>14-Feb-2011</b>	<b>Series</b> <b>2</b>	<b>Sheet</b> <b>317</b>



 LUDLUM MEASUREMENTS INC. SHEETWATER, TX.			
DR	CKB	02/14/96	TITLE: VOLTAGE DIVIDER BOARD
		BOARD: 5002-502	
DSGN	DL	02/14/96	MODEL: 1 1/2"
APP	JWS	10-24-07	FILENAME: BS002502
		11:59:05 14-Jan-04	
COMPONENT	SOLDER	REVISION	SERIES SHEET
OUTLINE	OUTLINE	1.0	2 318

## Energy Response for Ludlum Model 44-2

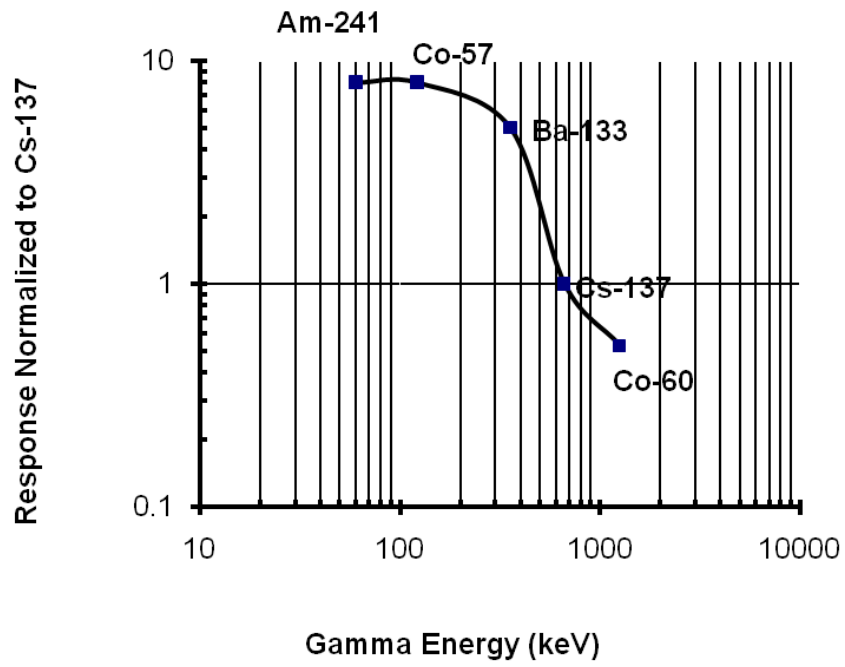

REVISION HISTORY

REV	DESCRIPTION	DATE	BY
1	VALID	4/12/2010	PW
2	REPLACED 2002-329 WITH 7002-328	6/5/2017	ACK

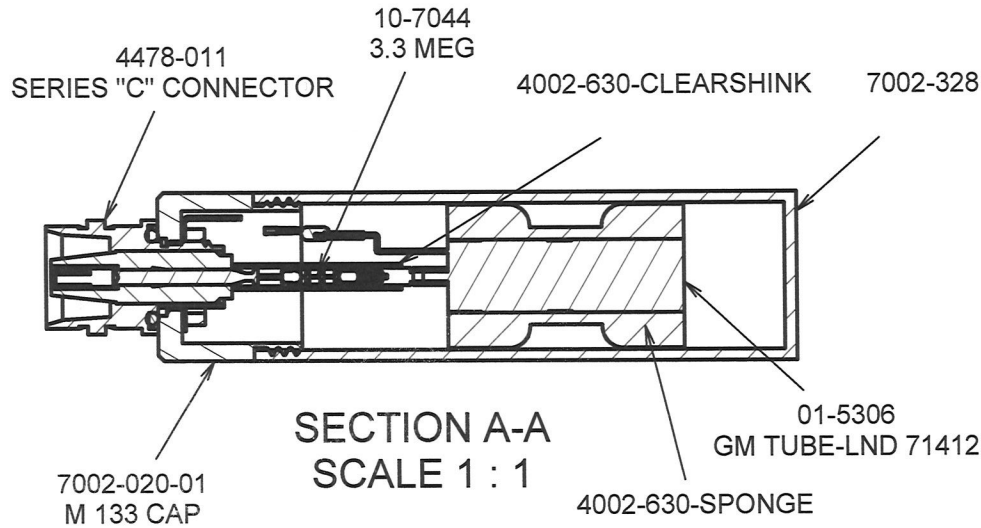

SECTION A-A  
SCALE 1 : 1

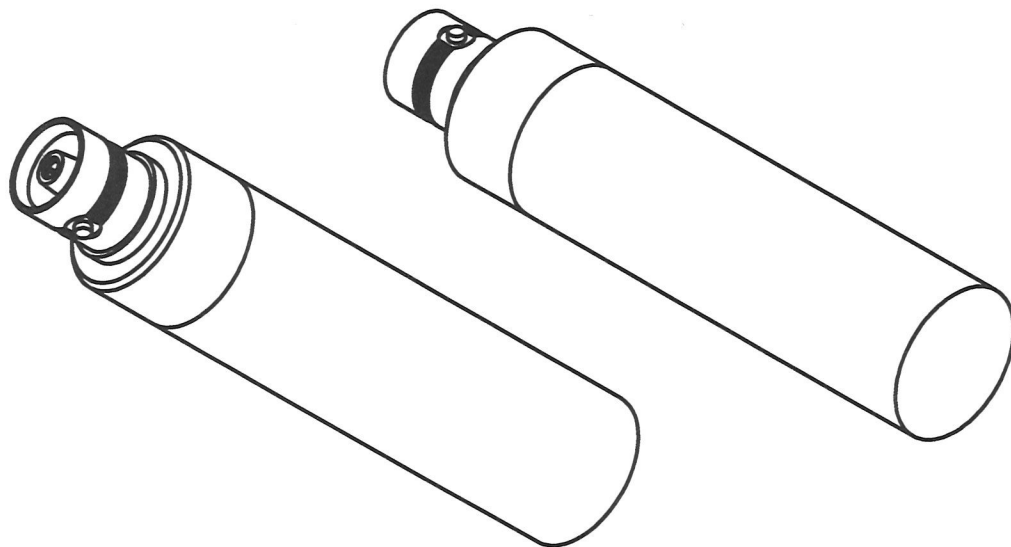
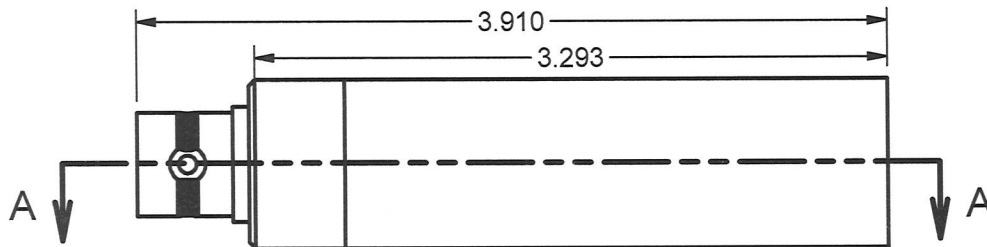

M 133-3  
TUBE:01-5048 GM TUBE-LND 713 (01-5311)  
RES: 10-7044 3.3 MEG 1/4W 5% CR25

M 133-4  
TUBE:01-5306 GM TUBE-LND 71412  
RES: 10-7044 3.3 MEG 1/4W 5% CR25

M 133-6  
TUBE:01-5298 GM TUBE-LND 71616 4G300  
RES: 10-7044 3.3 MEG 1/4W 5% CR25

M 133-7  
TUBE:01-5045 GM TUBE-CSF 3G70  
RES: 10-7052 2.2 MEG 1/4W 5% CR25  
THOMSON TUBE SHIELD 01-5055

M 133-8  
TUBE: 01-5053-CSF 3G10  
RES: 10-7030 4.7 MEG 1/4W 5% CR25  
THOMSON TUBE SHIELD 01-5055

M 133-8-5  
TUBE:01-5053 GM TUBE CSF 3G10  
RES: 10-7052 2.2 MEG 1/4W 5% CR25  
THOMSON TUBE SHIELD 01-5055

M 133-9  
TUBE 01-5306 GM TUBE-LND 71412  
RES: 10-7052 2.2 MEG 1/4W 5% CR25

M 133-10  
TUBE:01-5298 GM TUBE-LND 71616  
RES: 10-7052 2.2 MEG 1/4W 5% CR25

M 133-12  
TUBE:01-5336 GM TUBE-LND 71623 HIGH RANGE  
RES: 10-7031 10 MEG 1/4W 5% CR25

9-27-17  
2-12-17

DWN JAC	DATE 7/10/17	CHK	DATE	APP Jaw	DATE 7-12-17
DWG NUM: 4002-630				SCALE: 2:1	
TITLE M 133 ASSY DRAWING					
LUDLUM MEASUREMENTS, INC. 501 OAK STREET SWEETWATER, TEXAS 79556			SERIES 2	SHEET 634	



## RS-232 Output Formats

---

The Ludlum Model 2241 series of instruments has an RS-232 serial communications port that can be used to log readings and read or set instrument parameters. There are two formats available. Most Model 2241 instruments have the binary format outlined below, but some newer Model 2241-2 units have an ASCII output, which is also outlined below following the binary format explanation.

The RS-232 port is configured at 9600 baud, 8 data bits, no parity, and 1 stop bit (9600,8,N,1). Ludlum Measurements can supply a Windows-based software that can be used to help calibrate the instruments, but note that it will not communicate with the newer ASCII output Model 2241-2 units.

### Binary Output Format (15 Bytes)

BYTE01	RatemeterCPS+0	MSB
BYTE02	RatemeterCPS+1	
BYTE03	RatemeterCPS+2	
BYTE04	RatemeterCPE+3	LSB
BYTE05	Scaler+0	MSB
BYTE06	Scaler+1	
BYTE07	Scaler+2	
BYTE08	Scaler+3	
BYTE09	Scaler+4	LSB
BYTE10	CountTime+0	MSB
BYTE11	CountTime+1	LSB
BYTE12	CountTimeLeft+0	MSB
BYTE13	CountTimeLeft+1	LSB
BYTE14	Carriage Return (0DH)	
BYTE15	Line Feed (0AH)	

The ratemeter value is in cps and is scaled by a factor of 256. To get the ratemeter reading in cpm, take the value and divide by 256, and then multiply by 60.

**RS-232 Commands**

E – auto dump off

A – auto dump on

C – start scaler

F – set scaler count time

R – send parameters from instrument to computer

S – read parameters from computer to instrument

O – output once

All commands must be sent in upper case letters.

**Output of “R” Command – Read Parameters**

BYTE01	Detector+0	
BYTE02	DeadConstant+0	MSB
BYTE03	DeadConstant+1	LSB
BYTE04	CaConstant+0	MSB
BYTE05	CalConstant+1	
BYTE06	CalConstant+2	
BYTE07	CalConstant+3	
BYTE08	CalConstant+4	
BYTE09	CalConstant+5	LSB
BYTE10	RateAlarm+0	MSB
BYTE11	RateAlarm+1	
BYTE12	RateAlarm+2	
BYTE13	RateAlarm+3	
BYTE14	RateAlarm+4	LSB
BYTE15	ScalerAlarm+0	MSB
BYTE16	ScalerAlarm+1	
BYTE17	ScalerAlarm+2	
BYTE18	ScalerAlarm+3	
BYTE19	ScalerAlarm+4	LSB
BYTE20	CountTime+0	MSB
BYTE21	CountTime+1	LSB
BYTE22	Units+0	
BYTE23	TimeBase+0	
BYTE24	AudioDivideBy+0	
BYTE25	Response+0	
BYTE26	RateAlert+0	MSB
BYTE27	RateAlert+1	
BYTE28	RateAlert+2	
BYTE29	RateAlert+3	
BYTE30	RateAlert+4	LSB
BYTE31	CheckSource+0	MSB
BYTE32	CheckSource+1	
BYTE33	CheckSource+2	

BYTE34	CheckSource+3	
BYTE35	CheckSource+4	LSB
BYTE36	PercentCS+0	
BYTE37	MinDisplay+0	
BYTE38	Carriage Return (0DH)	
BYTE39	Line Feed (0AH)	

### Input of "S" Command – Send Parameters

BYTE1	DeadCosntant+0	MSB
BYTE2	DeadConstant+1	LSB
BYTE3	CalConstant+0	MSB
BYTE4	CalConstant+1	
BYTE5	CalConstant+2	
BYTE6	CalCosntant+3	
BYTE7	CalConstant+4	
BYTE8	CalConstant+5	LSB
BYTE9	RateAlarm+0	MSB
BYTE10	RateAlarm+1	
BYTE11	RateAlarm+2	
BYTE12	RateAlarm+3	
BYTE13	RateAlarm+4	LSB
BYTE14	ScalerAlarm+0	MSB
BYTE15	ScalerAlarm+1	
BYTE16	ScalerAlarm+2	
BYTE17	ScalerAlarm+3	
BYTE18	ScalerAlarm+4	LSB
BYTE19	CountTime+0	MSB
BYTE20	CountTime+1	LSB
BYTE21	Units+0	
BYTE22	TimeBase+0	
BYTE23	AudioDivdeBy+0	
BYTE24	Response+0	
BYTE25	RateAlert+0	MSB
BYTE26	RateAlert+1	
BYTE27	RateAlert+2	
BYTE28	RateAlert+3	
BYTE29	RateAlert+4	LSB
BYTE30	CheckSource+0	MSB
BYTE31	CheckSource+1	
BYTE32	CheckSource+2	
BYTE33	CheckSource+3	
BYTE34	CheckSource+4	LSB
BYTE35	PercentCS+0	
BYTE36	MinDisplay+0	

**Input of "F" Command – Set Count Time**

BYTE1	CountTime+0	MSB
BYTE2	CountTime+1	LSB

Units            0 = R  
                   1 = Sv  
                   2 = cpm

Timebase        0 = min  
                   1 = seconds

AudioDivide    0 = Auto  
                   1 = Manual

**ASCII Output Format**

This special firmware changes the format of the auto-dump from binary to ASCII. The output interval remains the same (2 seconds).

2241	Special Firmware 40804n10	08/06/2003
2241-2	Special Firmware 40806n13	04/04/2003
2241-3	Special Firmware 40806n16	07/07/2004

The old format was (binary):

Byte 1	Ratemeter CPS + 0
Byte 2	Ratemeter CPS + 1
Byte 3	Ratemeter CPS + 2
Byte 4	Ratemeter CPS + 3
Byte 5	Scaler + 0
Byte 6	Scaler + 1
Byte 7	Scaler + 2
Byte 8	Scaler + 3
Byte 9	Scaler + 4
Byte 10	Count Time + 0
Byte 11	Count Time + 1
Byte 12	Count Time Left + 0
Byte 13	Count Time Left + 1
Byte 14	Carriage Return (0DH)
Byte 15	Line Feed (0AH)

and is now replaced with (ASCII):

byte 1	x	Ratemeter
byte 2	x	Raetemter
byte 3	x	Ratemeter
byte 4	x	Ratemeter
byte 5	x	Ratemeter
byte 6	y	Display units
byte 7		Carriage Return (0DH)



byte 8                    Line Feed (0AH)

The ratemeter is displayed as 5 ASCII digits with a decimal, if necessary, and matches the LCD display on the 2241-2.

The display mode is a value from 0 to 9 representing the display units.

CPS	0
KCPS	1
CPM	2
KCPM	3
$\mu$ R	4
mR	5
R	6
$\mu$ Sv	7
mSv	8
Sv	9

**Note:** The LMI Model 2241 calibration software is not compatible with this firmware version.

Example output:

02.991	(=2.99 kcps)
01.801	(=1.80 kcps)
01.221	(=1.22 kcps)
00.831	(=0.83 kcps)
00.581	(=0.58 kcps)
004160	(=416 cps)