

**LUDLUM MODEL 44-98
BGO Scintillator**

November 2010

**LUDLUM MODEL 44-98
BGO Scintillator**

November 2010



LUDLUM MEASUREMENTS, INC
501 OAK STREET, P.O. BOX 810
SWEETWATER, TEXAS 79556
325-235-5494, FAX: 325-235-4672

STATEMENT OF WARRANTY

Ludlum Measurements, Inc. warrants the products covered in this manual to be free of defects due to workmanship, material, and design for a period of twelve months from the date of delivery. The calibration of a product is warranted to be within its specified accuracy limits at the time of shipment. In the event of instrument failure, notify Ludlum Measurements to determine if repair, recalibration, or replacement is required.

This warranty excludes the replacement of photomultiplier tubes, G-M and proportional tubes, and scintillation crystals which are broken due to excessive physical abuse or used for purposes other than intended.

There are no warranties, express or implied, including without limitation any implied warranty of merchantability or fitness, which extend beyond the description of the face there of. If the product does not perform as warranted herein, purchaser's sole remedy shall be repair or replacement, at the option of Ludlum Measurements. In no event will Ludlum Measurements be liable for damages, lost revenue, lost wages, or any other incidental or consequential damages, arising from the purchase, use, or inability to use product.

RETURN OF GOODS TO MANUFACTURER

If equipment needs to be returned to Ludlum Measurements, Inc. for repair or calibration, please send to the address below. All shipments should include documentation containing return shipping address, customer name, telephone number, description of service requested, and all other necessary information. Your cooperation will expedite the return of your equipment.

**LUDLUM MEASUREMENTS, INC.
ATTN: REPAIR DEPARTMENT
501 OAK STREET
SWEETWATER, TX 79556**

**800-622-0828 325-235-5494
FAX 325-235-4672**

Model 44-98 BGO Scintillator
November 2010

TABLE OF CONTENTS

1. GENERAL	1
2. SPECIFICATIONS:	1
REPLACEMENT PARTS LIST	2
Model 44-98 BGO Scintillator	2
Assembly View, Drawing 2 x 236	2
3.8 cm (1.5 in.) Tube Socket Board, Drawing 2 x 317	2
DRAWINGS AND DIAGRAMS	4

Model 44-98 BGO Scintillator
November 2010

Model 44-98 BGO Scintillator
November 2010

1. GENERAL

The Ludlum Model 44-98 BGO (Bismuth Germinate Oxide) detector is used primarily for the detection of low-energy gamma radiation. The Model 44-98 will also detect beta energy as low as 17 keV. Both ^{125}I and ^{14}C could be detected with the Model 44-98, for example.

The detector consists of a 1-inch diameter by 1-millimeter thick BGO scintillator. The

window area is approximately 5 cm^2 and is covered by 1.2 mg/cm^2 metalized Mylar for light tightness.

The Model 44-98 may be used with Ludlum instruments or equivalent instruments that can provide up to 1300 volts and have an input sensitivity of 5 mV to 10 mV.

2. SPECIFICATIONS:

- | | |
|--|---|
| ✓ Voltage Requirements: 500 volts to 1200 volts maximum | ✓ Efficiency (4π): 15%- ^{125}I ; 8%- ^{129}I ; 3%- ^{14}C |
| ✓ Scintillator: 2.5 cm (1 in.) diameter by 1 mm thick BGO crystal (non-hygroscopic) | ✓ Input Sensitivity: typically 5 to 10 mV |
| ✓ Photomultiplier Tube: 3.8 cm (1.5 inch) diameter, 10-stage, head-on type, magnetically shielded | ✓ Recommended Energy Range Operation: 10 keV to 145 keV gamma |
| ✓ Connector: Standard series "C," other types available upon request | ✓ Size: 4.8 x 18.7 cm (1.9 x 7.4 in.) (Dia x L) |
| ✓ Window Area: 5 cm^2 | ✓ Construction: Aluminum |
| ✓ Window Density: 1.2 mg/cm^2 | ✓ Weight: 0.5 kg (1 lb) |
| ✓ Background: 650 cpm or less (in a $10\text{ }\mu\text{R/hr}$ field) | ✓ Finish: polyurethane computer beige paint |

**Model 44-98 BGO Scintillator
November 2010**

REPLACEMENT PARTS LIST

Ref. No.	Description	Part No.
<u>Model 44-98 BGO Scintillator</u>		
UNIT	Completely Assembled Model 44-98 BGO Scintillator	47-2465

Assembly View, Drawing 2 x 236

● **MISCELLANEOUS**

*	PM Tube/Socket Assembly	4002-510
*	1.5" Photomultiplier Tube	01-5349
*	BGO Scintillator	01-5284
*	Window Assembly	2002-358
*	Light Pipe	7002-353
*	Gasket	7002-355
*	Tube Shield	40-4006
*	Connector, Series "C"	13-7751
2 EA.	Sponge	7002-029-05

3.8 cm (1.5 in.) Tube Socket Board, Drawing 2 x 317

*	Assembled Tube Socket Board	5002-502
---	-----------------------------	----------

● **CAPACITORS**

C1	0.01: μ F, 3kV 56430GAS10	04-5525
----	-------------------------------	---------

● **RESISTORS**

R2	1 MEG, ¼ W, 1%	12-7964
R1	10 MEG, ¼ W, 2%	10-7106
R3-R6	10 MEG, ¼ W, 2%	10-7106
R11	10 MEG, ¼ W, 2%	10-7106
R101-R104	10 MEG, ¼ W, 2%	10-7106
R111	10 MEG, ¼ W, 2%	10-7106

● **MISCELLANEOUS**

*	Contact #1434	18-9124
---	---------------	---------

DRAWINGS AND DIAGRAMS

Assembly View, Drawing 2 x 236

3.8 cm (1.5 in.) Tube Socket Board, Drawing 2 x 317

3.8 cm (1.5 in.) Tube Socket Component Layout, Drawing 2 x 318

Window Assembly, Drawing 2 x 232A

REV #	ALTERATIONS	DATE	BY
1	VALID ECF-739	1/21/98	ACF
2	VALID ECF-2118	8/15/07	CMC

MODEL 44-98 ASSEMBLY
47-2465

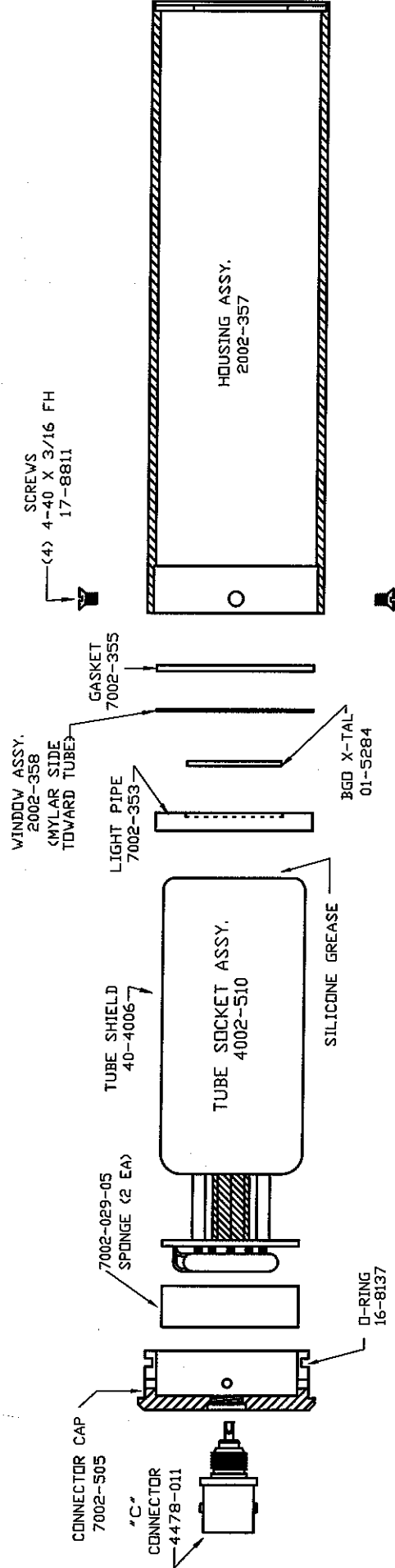

APP. DATE	CHK. DATE	SCALE	SHEET
CMC 8/15/07	8/15/07	4002-371	2
PART NUM		4002-371	2
TITLE		M 44-98 ASSY	236
LUDLUM MEASUREMENTS, INC. 500 GAK STREET SPRINGWATER, TEXAS 75566			

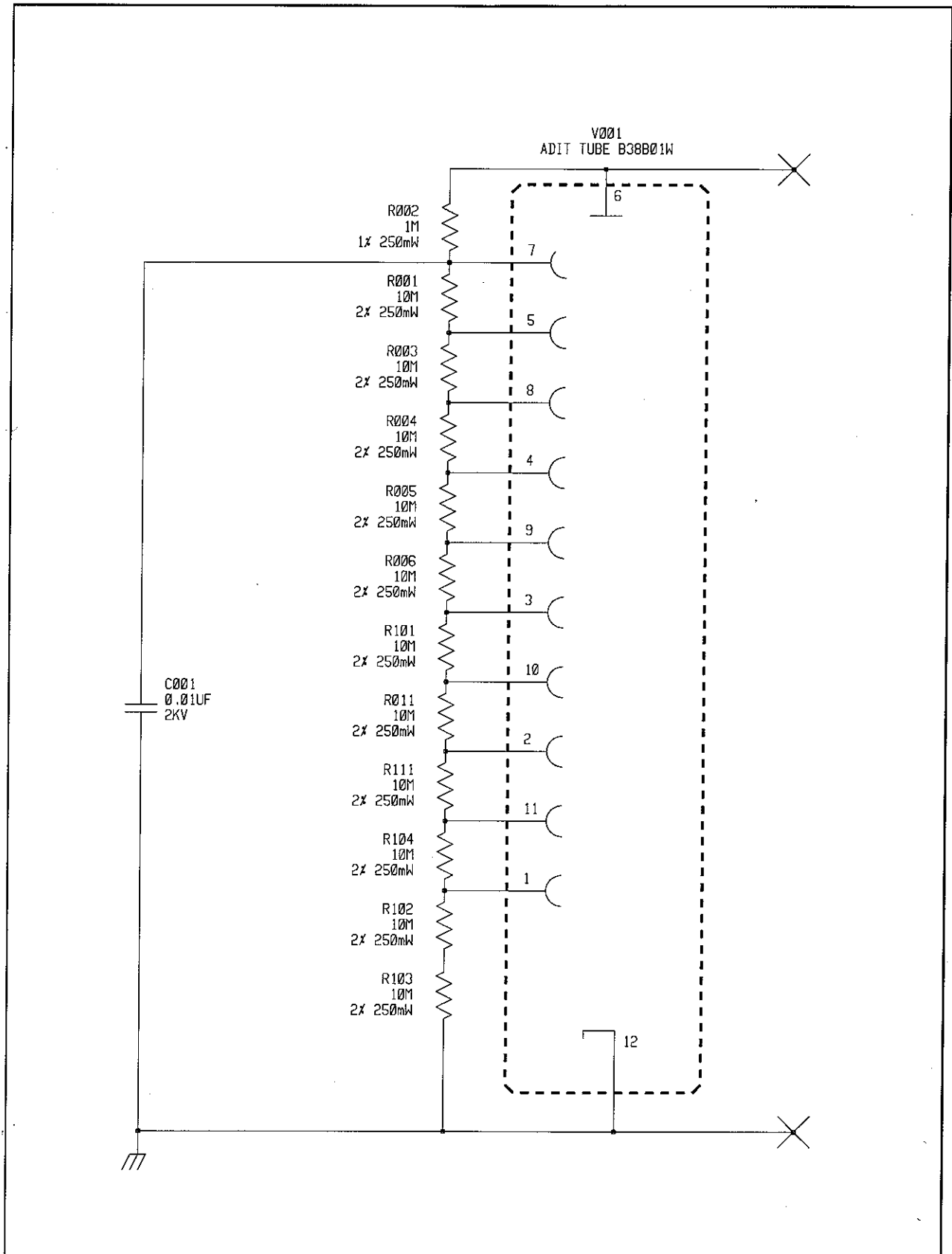

UPDATED		LUDLUM MEASUREMENTS INC.			
DR CKB	02/14/96	TITLE: 1 1/2" VOLTAGE DIVIDER BOARD			
CHK <i>AW</i>	<i>10-29-99</i>	BOARD# 5002-502			
DSGN DL	02/14/96	SIZE	MODEL	SERIES	SHEET
APPD <i>RBS</i>	<i>10-27-99</i>	C	-	2	317
NEXT HIGHER ASSY.					
14:32:55	29-Oct-99	SB002502		SHEET 1 OF 1	

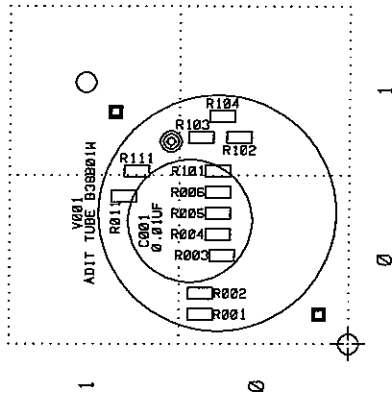

 LUDLUM MEASUREMENTS INC. SHEETWATER, TX.			
DR	CKB	02/14/96	TITLE: VOLTAGE DIVIDER BOARD
DISC	DL	02/14/96	BOARD: 5002-502
APP'NG	COMPONENT	10-24-07	MODEL: 1 1/2"
DATE	REV	11/25/05	FILENAME: 6502502
OUTLINE	OUTLINE	1, 0	14-Jan-84
		2	REVISION SERIES
			SHEET
			318

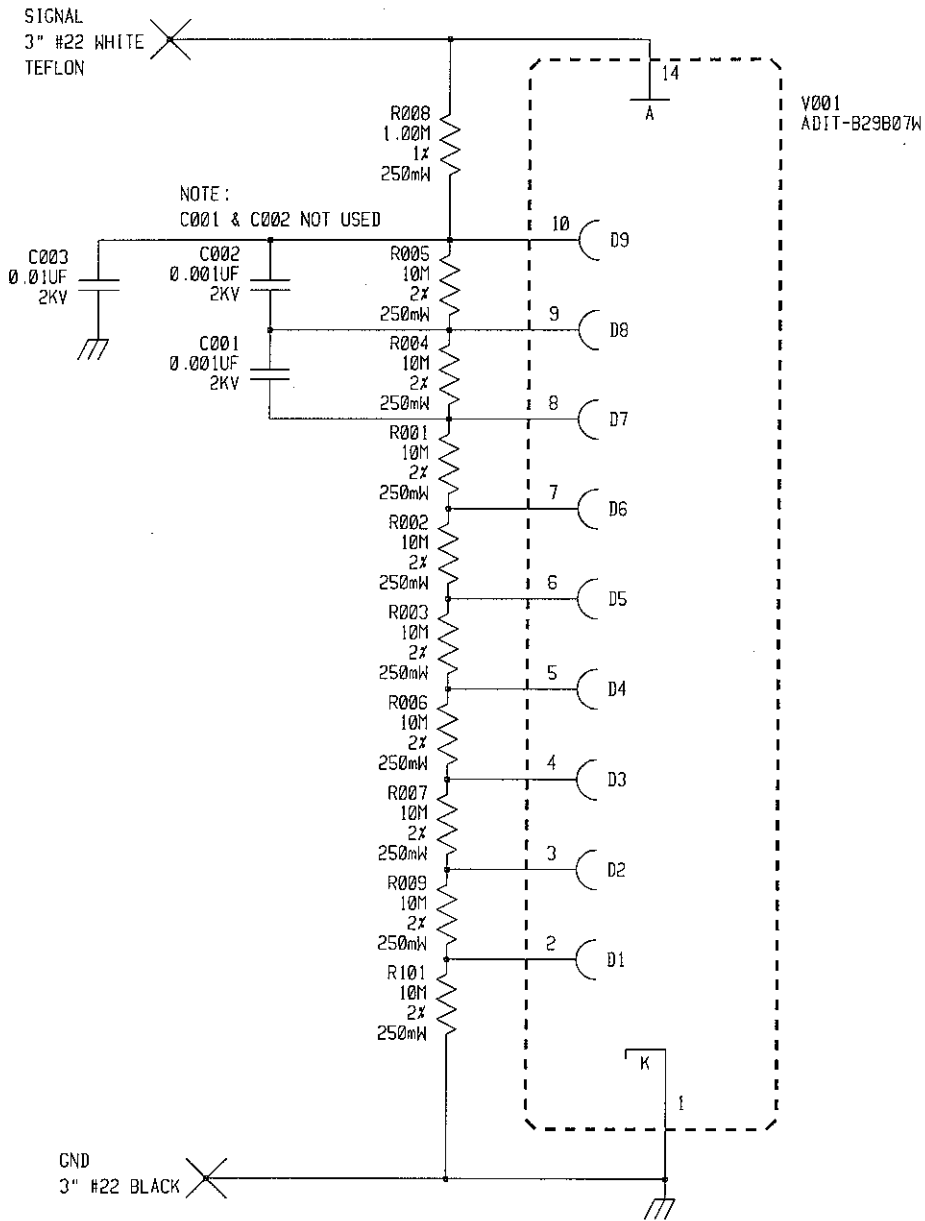

UPDATED	-		LUDLUM MEASUREMENTS INC.			
DR	CKB	25-NOV-97	TITLE: 1.125" VOLTAGE DIVIDER 9 STAGE			
DSCN	RC	25-NOV-97	BOARD# 5002-570			
APPD	<i>RS</i>	<i>13J407</i>	SIZE	MODEL	SERIES	SHEET
			C	1.125"	2	232
14:06:06		7-Feb-06	SB002570		SHEET 1 OF 1	

MODEL 44-98
 WINDOW ASSEMBLY
 2002-358



PHENOLIC RING
 7002-354

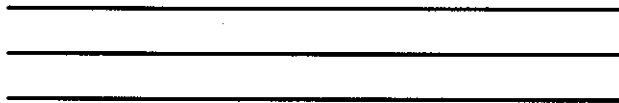

3LAYERS OF
 ALUMINIZED MYLAR
 01-5175

CHG	NO.		DWN	CHK	APP
DWN	DATE	CHK	DATE	APP	DATE
TJR	09-12-96	NBW	2-14-97	BH	2-14-97
TOL: SHOP STD <input type="checkbox"/>			SCALE: FULL <input type="checkbox"/>		
OTHER			OTHER		
TITLE M 44-98					
 LUDLUM MEASUREMENTS, INC. 501 OAK STREET SWEETWATER, TEXAS 79556			SERIES	SHEET	
			2	232A	