

# **Model 3277/1 Desktop Frisking Station**

**Ludlum Measurements**

**January 2024**

**Firmware: 1.10.4 and Higher**



# Model 3277/1 Desktop Frisking Station

Ludlum Measurements

January 2024

Firmware: 1.10.4 and Higher



**LUDLUM MEASUREMENTS, INC**  
501 OAK STREET, P.O. BOX 810  
SWEETWATER, TEXAS 79556  
325-235-5494, FAX: 325-235-4672



## **STATEMENT OF WARRANTY**

Ludlum Measurements, Inc. warrants the products covered in this manual to be free of defects due to workmanship, material, and design for a period of twelve months from the date of delivery. The calibration of a product is warranted to be within its specified accuracy limits at the time of shipment. In the event of instrument failure, notify Ludlum Measurements to determine if repair, recalibration, or replacement is required.

This warranty excludes the replacement of photomultiplier tubes, G-M and proportional tubes, and scintillation crystals which are broken due to excessive physical abuse or used for purposes other than intended.

There are no warranties, express or implied, including without limitation any implied warranty of merchantability or fitness, which extend beyond the description of the face thereof. If the product does not perform as warranted herein, purchaser's sole remedy shall be repair or replacement, at the option of Ludlum Measurements. In no event will Ludlum Measurements be liable for damages, lost revenue, lost wages, or any other incidental or consequential damages, arising from the purchase, use, or inability to use product.

## **RETURN OF GOODS TO MANUFACTURER**

If equipment needs to be returned to Ludlum Measurements, Inc. for repair or calibration, please send to the address below. All shipments should include documentation containing return shipping address, customer name, telephone number, description of service requested, and all other necessary information. Your cooperation will expedite the return of your equipment.

**LUDLUM MEASUREMENTS, INC.**

**ATTN: REPAIR DEPARTMENT**

**501 OAK STREET**

**SWEETWATER, TX 79556**

**800-622-0828**

**325-235-5494**

**FAX 325-235-4672**



# CONTENTS

<b>Contents</b>	<b>3</b>
<b>List of Figures</b>	<b>5</b>
<b>List of Tables</b>	<b>7</b>
<b>1 Introduction</b>	<b>9</b>
<b>2 Getting Started</b>	<b>11</b>
2.1 Unpacking and Repacking . . . . .	11
2.1.1 Powering the Unit . . . . .	11
2.2 Instrument Operational Test . . . . .	12
2.3 Instrument Use and Controls . . . . .	13
2.3.1 Main Display . . . . .	13
2.3.2 Status Bar . . . . .	13
2.3.3 Button Bar . . . . .	14
2.4 Detector Sensor . . . . .	17
2.5 Detector Fail Diagnostics . . . . .	17
2.6 Source Check . . . . .	17
2.7 Background Subtract . . . . .	17
2.8 Backup Battery . . . . .	18
<b>3 Normal Operation</b>	<b>19</b>
3.1 Idle State . . . . .	19
3.1.1 Idle Rate . . . . .	20
3.1.2 Idle Background . . . . .	20
3.2 Manual Count . . . . .	20
3.3 Frisk . . . . .	20
<b>4 Backup Battery</b>	<b>21</b>
4.1 Accessing Battery Compartment . . . . .	22
4.2 Connecting Battery . . . . .	22
4.3 Recovering Overly Discharged Battery . . . . .	22
4.4 Replacing Battery . . . . .	23
<b>5 Source Check</b>	<b>25</b>
5.1 Performing a Source Check . . . . .	25
5.1.1 Open Source Check Menu . . . . .	25
5.1.2 Select Detector . . . . .	25
5.1.3 Select Source . . . . .	26
5.1.4 Start Source Check . . . . .	26
5.1.5 Results . . . . .	27

---

<b>6</b>	<b>Settings</b>	<b>29</b>
6.1	Basic Usage . . . . .	29
6.2	Settings Menus . . . . .	31
6.2.1	General Settings . . . . .	31
6.2.2	Idle Settings . . . . .	32
6.2.3	MCT Settings . . . . .	33
6.2.4	Manual Count Settings . . . . .	34
6.2.5	Frisk Settings . . . . .	34
6.2.6	Source Check Settings . . . . .	35
6.2.7	Set Time . . . . .	36
6.2.8	Calibration Settings . . . . .	36
6.3	Info Menu . . . . .	37
6.4	System Control Menu . . . . .	38
<b>7</b>	<b>Detector Board Calibration/Configuration</b>	<b>39</b>
7.1	Required for operation . . . . .	39
7.2	Calibration Parameters . . . . .	40
7.2.1	Idle Alarm Values . . . . .	41
7.2.2	Rate and Count Alarm Values . . . . .	41
7.2.3	Ignored Parameters . . . . .	41
<b>8</b>	<b>Specifications</b>	<b>43</b>
8.1	Model 3277/1 System . . . . .	43
<b>9</b>	<b>Revision History</b>	<b>45</b>
<b>10</b>	<b>Recycling</b>	<b>47</b>
<b>A</b>	<b>Drawings</b>	<b>49</b>
A.1	Frisker Mounting Options . . . . .	50
A.2	M3277/1 Hole Template . . . . .	51



# LIST OF FIGURES

2.1	Splash-screen/Wallpaper . . . . .	12
2.2	System Idle . . . . .	12
2.3	Readings . . . . .	13
2.4	Status Bar . . . . .	14
2.5	Button Bar . . . . .	15
2.6	Cradle Sensor . . . . .	17
4.1	Battery Access Screws . . . . .	22
4.2	Battery Mounting Screws . . . . .	24
5.1	Source Check - Detector Selection . . . . .	26
5.2	Source Check - Source Selection . . . . .	27
5.3	Source Check - Start Count . . . . .	27
5.4	Source Check - Results . . . . .	28
5.5	Source Check - Current . . . . .	28
6.1	Settings - Login . . . . .	30
6.2	Settings - Keypad . . . . .	31
6.3	Settings - Enter User ID . . . . .	31
7.1	Calibration Port . . . . .	39
7.2	Count Alarm Example - Background Off . . . . .	41
7.3	Count Alarm Example - Background On . . . . .	41



# LIST OF TABLES

2.1	Power Status . . . . .	14
2.2	Run Mode Buttons . . . . .	15
2.3	Run Mode Icons and Tap Controls . . . . .	16
2.4	Run Mode Long Press Functions . . . . .	17
3.1	Model 3002 Auto Response Times . . . . .	19
5.1	Source Check - Source Status . . . . .	26
6.1	Settings - User IDs . . . . .	29
6.2	Settings Buttons . . . . .	30
6.3	General Settings . . . . .	32
6.4	Idle Settings . . . . .	33
6.5	MCT Settings . . . . .	34
6.6	Manual Count Settings . . . . .	34
6.7	Frisk Settings . . . . .	35
6.8	Source Check Settings . . . . .	35
6.9	Set Time . . . . .	36
6.10	Calibration Settings . . . . .	37
6.11	Info . . . . .	37
6.12	System Control . . . . .	38
7.1	Required Parameter Settings . . . . .	40
7.2	Calibration Parameters . . . . .	40
7.3	Ignored Parameters . . . . .	41



## INTRODUCTION

The Model 3277/1 is a wall-mount or desktop instrument that can be used for frisking personnel or objects for alpha and beta contamination. The detection circuitry of the Model 3277/1 is powered by a Model 3002 main board. This allows calibration in the well-known Model 3000 ecosystem.

A large, color touch-screen displays alpha and beta readings simultaneously, and dual tone click-audio enables the user to easily distinguish between alpha and beta contamination.

The system can communicate through a standard Ethernet connection for remote monitoring. The unit is operated with from a 120 Vac domestic outlet with the use of a 12 Vdc transformer for operation from 0 to 40 °C (32 to 104 °F). A built-in battery provides approximately 8 hours of operation. A low-battery indicator on the LCD warns when less than 2 hours of battery life remain.

Setup of the instrument is accomplished through the touch-screen display. Calibration requires software available from Ludlum Measurements.



## GETTING STARTED

### 2.1 Unpacking and Repacking

Remove the calibration certificate and place it in a secure location. Remove the instrument and ensure that all of the items listed on the packing list are in the carton. Check individual item serial numbers and ensure calibration certificates match between instruments and detectors (if applicable). The Model 3277/1 serial number is located on the bottom left corner of the front face of the unit.

To return an instrument for repair or calibration, provide sufficient packing material to prevent damage during shipment. Every returned instrument must be accompanied by an **Instrument Return Form**, which can be downloaded from the Ludlum website at [www.ludlums.com](http://www.ludlums.com). Find the form by clicking the “Support” tab and selecting “Repair and Calibration” from the drop-down menu. Then choose the appropriate Repair and Calibration division where you will find a link to the form.

#### 2.1.1 Powering the Unit

Connect instrument to mains power and allow battery to fully charge before running on battery power. See Section 2.8 for more information on battery maintenance.

##### First Power Up

1. Remove fuse and slotted fuse cap from attached fuse container.
2. Install fuse into slotted fuse cap.
3. Install fuse and slotted fuse cap into fuse holder and tighten.
4. Connect power supply to instrument and tighten the lock screw.
5. Plug transformer into wall.
6. Set the power switch to the *ON* position.

## 2.2 Instrument Operational Test

After powering on the instrument, it should start booting. Observe the device during this time. If the LCD does not show the Ludlum logo after a few seconds, or audio fails to work, the device is in need of repair. Please refer to Figure 2.1.



Figure 2.1: Splash-screen/Wallpaper

The instrument will then move to normal operation, displaying the current rate for all detectors as shown in Figure 2.2. The unit should be ready to use at this time.

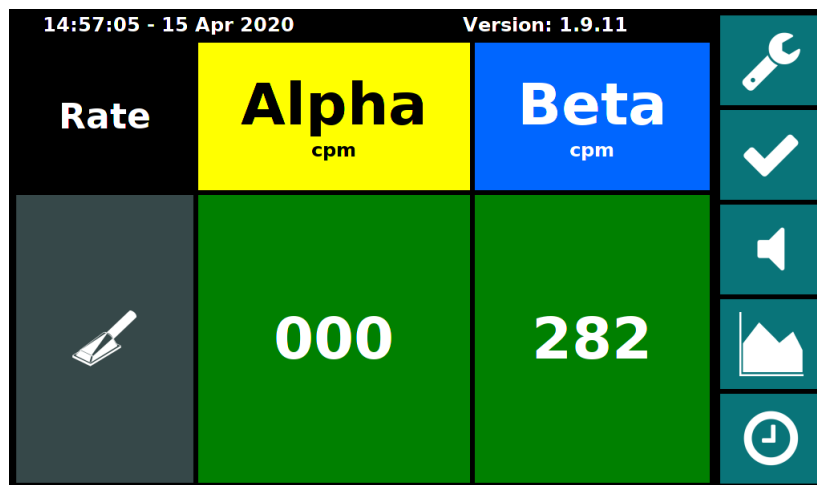

Figure 2.2: System Idle

If the source check lockout feature is enabled, the user may be locked out of using the instrument until a source check has been completed. Please see Chapter 5 for details on performing a source check.

Once this procedure has been completed, the instrument is ready for use.



## 2.3 Instrument Use and Controls

With the color touch-screen display, the Ludlum Model 3277/1 is simple and easy to use with minimal training required. While in normal running mode, the unit will look similar to Figure 2.2.



After the system sits idle, the screen may blank. Any touch of the display or activation of any of the sensors will immediately return the display to normal operation.

### 2.3.1 Main Display

The main display area (Figure 2.3) shows the current readings. The number of detector rows may change depending on the current operation. The top left box indicates the current readings mode.

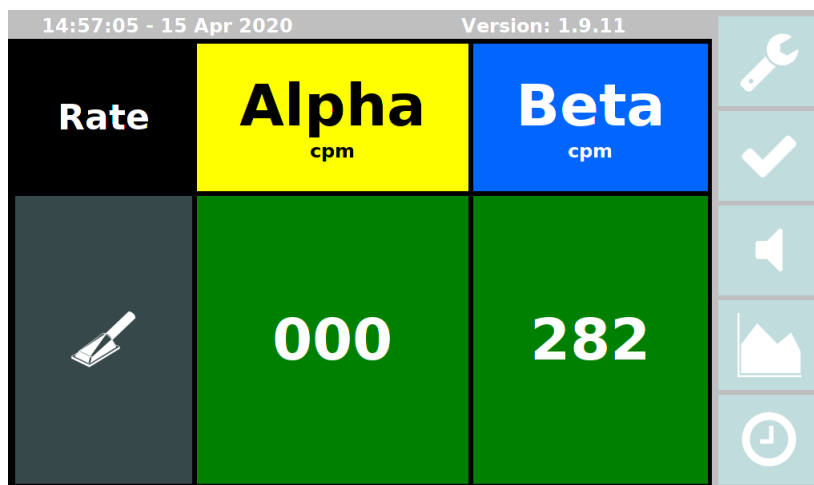

Figure 2.3: Readings

### 2.3.2 Status Bar

The status bar (Figure 2.4) shows the current time, version of the application, and battery/-supply voltage if available. Table 2.1 describes the power status.

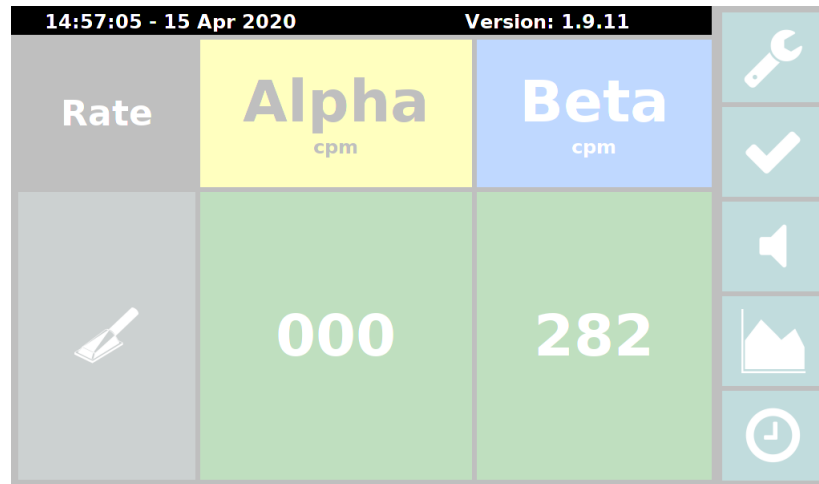

Figure 2.4: Status Bar

Table 2.1: Power Status

Prefix	Meaning
Full:	Battery is at or near full charge
Charging:	Battery is currently charging
Bat:	Running on battery power
Low Bat:	Running on battery power and battery is low
Crit. Bat:	Running on battery and battery is very low, will shutdown very soon
Supply:	Supply voltage, battery telemetry is not available
<No Status>	Battery and supply voltages not available

### 2.3.3 Button Bar

The button bar (Figure 2.5) shows the main controls/indicators for the current state of operation. Table 2.2 describes the general function of the buttons that can be seen during normal operation.

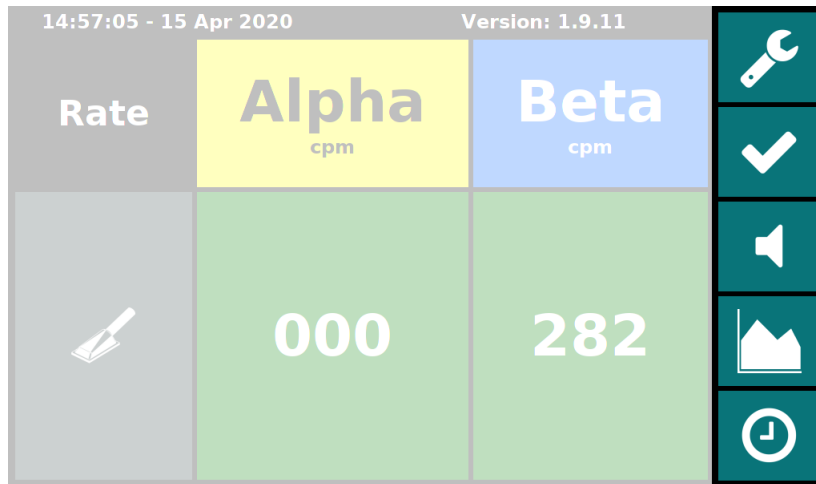











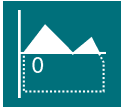

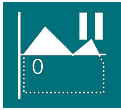



Figure 2.5: Button Bar

Table 2.2: Run Mode Buttons

	Settings Menu
	Acknowledge Alarms
	Click Audio
	Background Subtract
	Mode

The buttons can also be interacted with by touching them. Table 2.3 describes what each icon means and what happens if you tap the button.

Table 2.3: Run Mode Icons and Tap Controls

Icon	Current State	Touch Function
	Run State (Not Settings)	Enter settings menu
		Mute alarm tone and clear alarm message
	Click Audio Muted	Unmute click audio <sup>1</sup>
	Click Audio Enabled	Mute click audio <sup>1</sup>
	Background subtract off	Turn on background subtract <sup>1</sup>
	Background subtract on	Turn off background subtract <sup>1</sup>
	Background subtract off and updating of the background value is paused	Turn on background subtract <sup>1</sup>
	Background subtract on and updating of the background value is paused	Turn off background subtract <sup>1</sup>
	Current readings are rate	Go to count mode and start manual count <sup>1</sup>
	Current readings are background rate	Go to count mode and start manual count <sup>1</sup>
	Current readings are count	Return to rate readings <sup>1</sup>

<sup>1</sup> Manual touch control can be disabled in settings

Some buttons have extended features by pressing, holding for more than 1 second, and then releasing. Table 2.4 lists their functions.

Table 2.4: Run Mode Long Press Functions



Show current background values

## 2.4 Detector Sensor

The Ludlum Model 3277/1 has a sensor for the cradle (Figure 2.6). When the sensor is activated, the frisker icon on the display will light up to indicate the sensor has been activated.

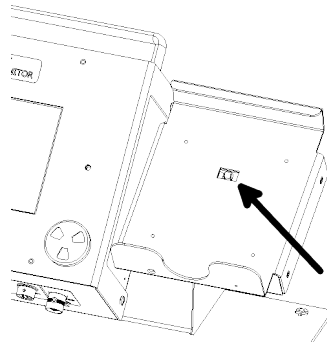

Figure 2.6: Cradle Sensor

## 2.5 Detector Fail Diagnostics

Note that the Model 3277/1 has its own diagnostic tests to ensure that the detector is functioning correctly. The Model 3277/1 can detect when the radiation detector is malfunctioning and will display an error. If the detector stops detecting radiation for a settable number of seconds, the Model 3277/1 will display "LOC" instead of a reading. This indication is common if the unit is powered up without a detector connected. If this indication is observed with a connected detector, remove the unit from service and have it evaluated by a qualified repair and calibration technician.

## 2.6 Source Check

A source check function can be enabled on the Model 3277/1. When the source check is enabled, the unit will take itself out of service if a source check has not been performed at the configured interval. See Chapter 5 for more details.

## 2.7 Background Subtract

The Model 3277/1 accumulates background counts in a sliding window while running. The sliding window is empty at power-on and will store up to five minutes of background readings.

The following events will inhibit background accumulation during and for a few seconds after the event. A few seconds of data before the event will also be removed from the buffer.

- Any Detector Sensor Active
- While in Source Check Menu
- While in Manual Count

## **2.8 Backup Battery**

The Model 3277/1 is equipped with an internal backup battery. The battery backup is intended to be used for a few hours during power outages or for temporary portable operation. See Chapter 4 for more information.

## NORMAL OPERATION

The normal operating modes of the Model 3277/1 can be categorized into a few different states. Each of these states is described in the following sections.

- Idle
- Manual Count
- Frisk

Table 3.1 lists the response times for rate or idle rate modes listed in the following sections.

Table 3.1: Model 3002 Auto Response Times

Count Rate	Auto Response Time: Fast (Seconds)	Auto Response Time: Slow (Seconds)
Less than 3 kcpm (50 cps)	10.5	21
Between 3 kcpm and 4 kcpm (67 cps)	8.4	16.8
Between 4 kcpm and 6 kcpm (100 cps)	6.3	12.6
Between 6 kcpm and 12 kcpm (200 cps)	4.2	8.4
More than 12 kcpm	2.1	4.2

### 3.1 Idle State

"Idle" for the Model 3277/1 is defined as the normal condition the unit is in when the frisker is in the cradle and the unit is not in a source check lockout. Normally the Model 3277/1 will boot up and is automatically "Idle." If something triggers another state, the unit will automatically return to "Idle" when the triggers are cleared.

The Model 3277/1 can be configured to show the current rate or the current background average while "Idle." This state also has its own dedicated alarm points that can be configured. See subsection 6.2.2 for information on how to access the settings for the idle state.



Idle mode alarm points are only active while in the "Idle" state. Alarm points are non-latching.

### 3.1.1 Idle Rate

Idle Rate is the typical rate meter values seen on the **Model 3002 with a response rate configured to auto slow**. See Table 3.1.

### 3.1.2 Idle Background

Idle Background is a live view of the accumulated background displayed in the same units rate is configured for. This is the same five-minute rolling background value that is used for background subtract.



If a condition that pauses updating of the background is active, the displayed value will not change as it is a view of the paused background value. This is an unusual scenario to see both Idle Background while also paused but worth mentioning.

## 3.2 Manual Count

A manual count will override the current state/mode and go to count mode readings and units.

## 3.3 Frisk

Frisk state is engaged when the frisker is removed from the cradle. The display will only show the frisker readings and automatically enable background subtract and click audio. The values shown will be rate meter readings with a **Model 3002 response rate of auto fast**. See Table 3.1.

While in the frisk state, you can also start a manual count by tapping the mode button. See Section 3.2 for more details.



## BACKUP BATTERY

The charger circuit automatically maintains the battery in optimal health while connected to wall power. However, there are a few caveats:



Even deep cycle lead acid batteries degrade quickly when they are deeply discharged. To maintain long battery life, it is recommended to discharge the battery to no more than 50% of capacity. That equates to roughly 4 hours of run-time on a new battery with this instrument.



If the 12-volt battery is discharged to below 7 volts, the internal charger circuitry will not attempt to charge the battery when wall power is re-applied. This is a safety measure to protect against incorrect installation of a 6-volt battery.



Similar to a modern car, there are small parasitic loads on the battery even when the unit is off. **If the unit is going to be left disconnected from wall power for a prolonged period, it is recommended to disconnect the battery by removing the battery fuse and storing the fuse and fuse holder in the fuse container.**

A new fully charged battery can become discharged below 7 volts within 70-80 days.



If the unit is powered from batteries until shutdown and left disconnected from wall power, a new battery can become discharged below 7 volts within 4 days.



Ludlum Measurements, Inc. recommends replacing the batteries every four years.

The following sections describe various maintenance procedures that may need to be performed on the battery.

## 4.1 Accessing Battery Compartment

To access the battery, remove the six screws shown in Figure 4.1, and move the cover to the side.

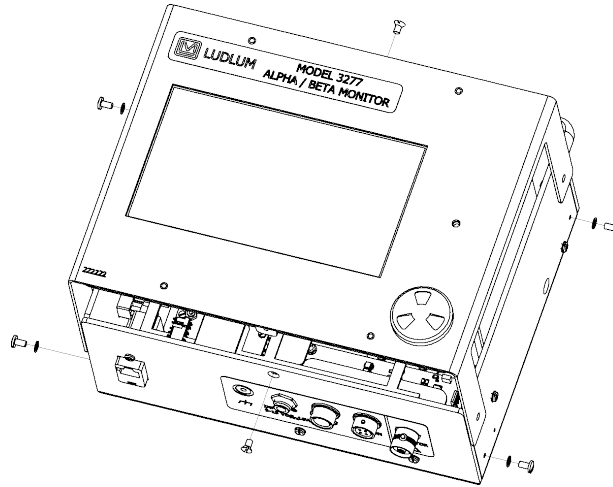

Figure 4.1: Battery Access Screws

## 4.2 Connecting Battery

When receiving a new instrument, the battery is disconnected by means of battery fuse removal. The following procedure describes how to properly connect the battery.

1. Remove fuse and slotted fuse cap from attached fuse container.
2. Install fuse into slotted fuse cap.
3. Install fuse and slotted fuse cap into fuse holder and tighten.

## 4.3 Recovering Overly Discharged Battery

If you experience an overly discharged battery below 7 volts, you can attempt to manually recharge with the following method. To perform this task you will need a battery charger designed to charge a 12-volt lead acid battery.

1. Remove the cover to access the battery. Refer to Section 4.1 for screw locations.
2. Disconnect battery wires by pulling on the housing of the blade connectors of each terminal.

3. Connect 12-volt lead acid battery charger to the battery terminals by attaching the positive lead to the red battery terminal and the negative lead to the black terminal.
4. Activate charger to a charge current of 1.8 amps or less.
5. Leave connected for a few minutes to allow the batteries resting voltage to rise about 7 volts.
6. Remove charger.
7. Reconnect instrument connections.
8. Replace cover and screws.
9. Immediately plug Model 3277/1 into wall power and allow unit to fully charge the battery.



You can turn the instrument on to monitor the battery voltage and verify it is charging by monitoring the battery voltage displayed in the top right corner of the display.

## 4.4 Replacing Battery

Periodically over the life of the instrument the battery will need to be replaced. The following procedure describes how to replace the battery.

1. Remove the cover to access the battery. Refer to Section 4.1 for screw locations.
2. Disconnect battery wires by pulling on the housing of the blade connectors of each terminal.
3. Remove battery mounting strap nuts. Refer to Figure 4.2 for nut locations.
4. Remove battery. Taking care to not damage temperature probe wrapped into foam.
5. Remove foam from old battery and reuse foam or replace foam on new battery. Ensure temperature probe is wrapped inside touching battery, near middle of battery.
6. Install new battery and battery strap.
7. Tighten nuts.
8. Reconnect instrument connections.
9. Replace cover and screws.

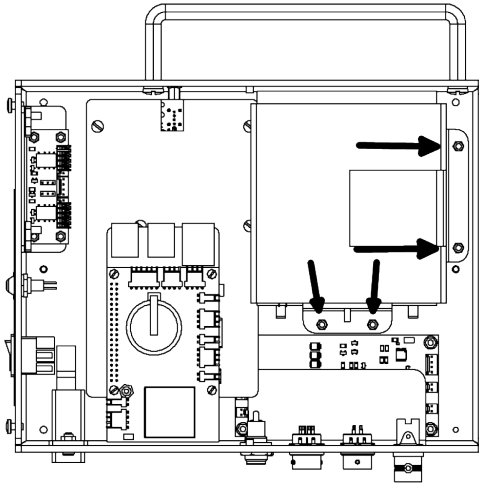

Figure 4.2: Battery Mounting Screws

## SOURCE CHECK

A source check feature can be enabled on this instrument. See subsection 6.2.6 for settings to enable the source check. If the source check is enabled and expired, the instrument will be out of service until a source check is successfully passed. If the source check feature is disabled or the source check is current, the instrument will operate normally.

### 5.1 Performing a Source Check

The following steps are an overview of performing a source check. The following sections describe each step in more detail.

1. Open source check menu
2. Select detector
3. Select source
4. Start source check
5. Pass or fail the results
6. Repeat until all sources on all detectors have been passed

#### 5.1.1 Open Source Check Menu

A source check can be started by clicking on the settings button from the main screen. See Table 2.2. The user ID for performing a source check is "2222."

#### 5.1.2 Select Detector

The base menu of the source check function is the detector selection screen (Figure 5.1). Tap the desired detector to perform a source check test on that detector.

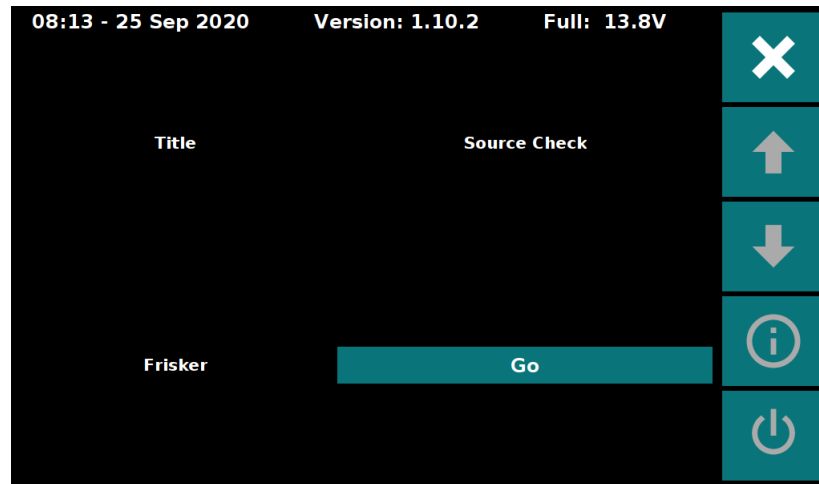

Figure 5.1: Source Check - Detector Selection

### 5.1.3 Select Source

The next step is to select a source to test for the source check (Figure 5.2). Every source must have a source check performed to complete the source check. The label to the left of the source describes the current state. See Table 5.1 for details.

As each source has been performed and **Passed**, they will have a number of hours that will temporarily remain valid. When all source tests on all detectors have been passed, this will change to **Current** status, and the number of hours will change to the number of hours remaining until the source check expires again.

If a source check is **Current** and a new source check test is performed and **Failed**, the instrument will go into the source check expired state. If the failed source(s) are then re-run and **Passed**, the source check will resume the previous expiration time.

Table 5.1: Source Check - Source Status

Status	Meaning
Current:	Source check is valid and not required at this time
Expired:	Source check has expired and needs to be performed
Failed:	Source check has been run and given a failed status
Passed:	Source check has been run and given a passing status

### 5.1.4 Start Source Check

After selecting the source to check, the application will wait for the user to start the source check count (Figure 5.3). The check source should be placed on the appropriate detector, or all sources removed for background, before tapping the start button. Once pressed, the count will start with the configured amount of counting time.

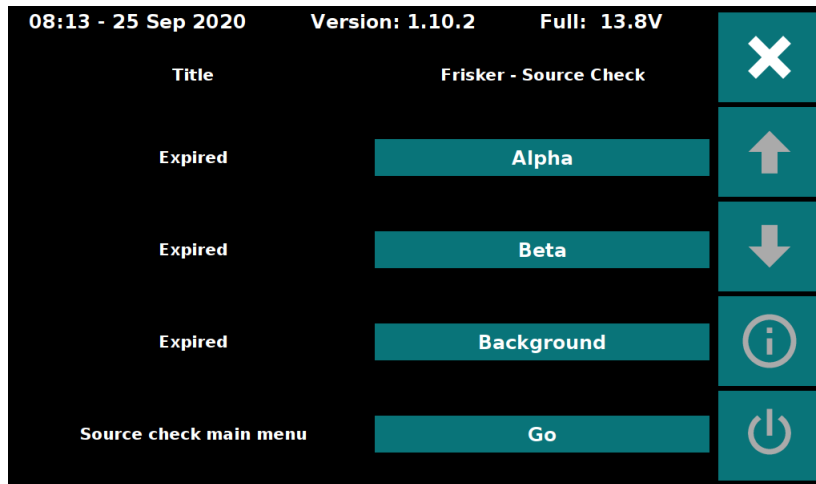

Figure 5.2: Source Check - Source Selection

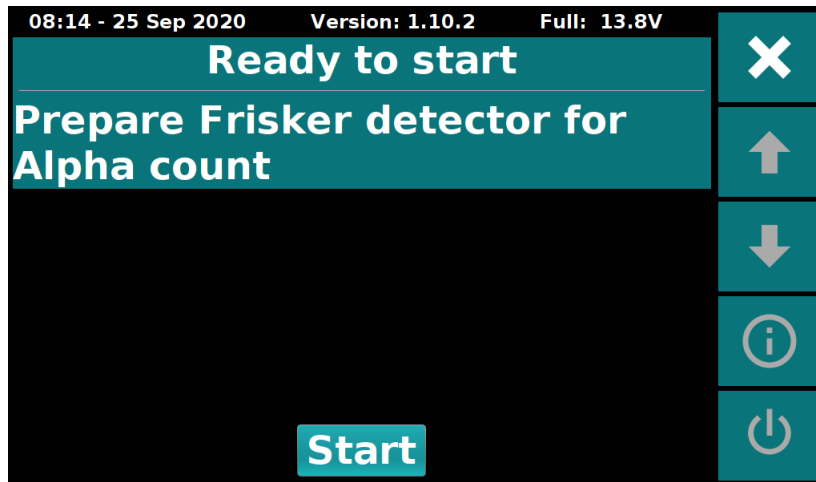

Figure 5.3: Source Check - Start Count

### 5.1.5 Results

When a source check test count has been completed, the results will be shown to the user (Figure 5.4). The user will have to decide if the test is a pass or fail. Once the user selects the pass or fail status, the display will return to the source test selection screen. If this test is a passing one and is also the final one to complete the source check, there will be a dialog (Figure 5.5) informing the user that all tests have been completed and detailing how long until the next source check is required.

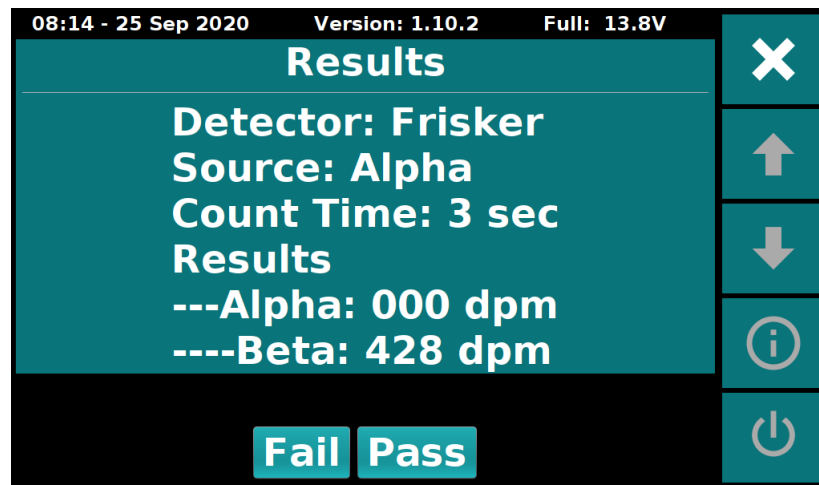

Figure 5.4: Source Check - Results

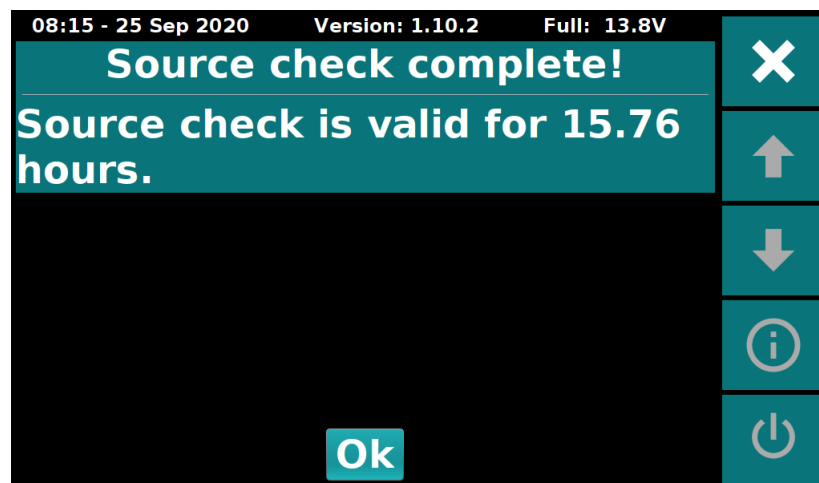

Figure 5.5: Source Check - Current



## SETTINGS

General settings on the Model 3277 are easily accessed via the touch-screen interface.



Calibration is not accessed through the settings menu. See Chapter 7 for details.

The Model 3277 has two user levels. The top level has the options to configure how the instruments perform. The second user level is for performing a source check.

Table 6.1: Settings - User IDs

User	ID	Password	Privileges
Admin	1111	<none>	Configure instrument operation
Source Check	2222	<none>	Performs source check









The following sections list the options available to the **Admin** user. For more information on the **Source Check** user, see Chapter 5.

### 6.1 Basic Usage

Entering the settings menu is accomplished by clicking the "Enter Settings Menu" icon from the main screen (Table 6.2). To exit the settings menu, press the "Exit Settings Menu" button. Table 6.2 shows the typical buttons in the start menu. Some buttons may be greyed out indicating they have no function.

Table 6.2: Settings Buttons

	Enter Settings Menu
	Exit Settings Menu
	Previous Menu
	Next Menu
	Info Menu
	System Control Menu

The user login screen looks like Figure 6.1. Click in the box to the right of "User ID" to bring up the keypad.

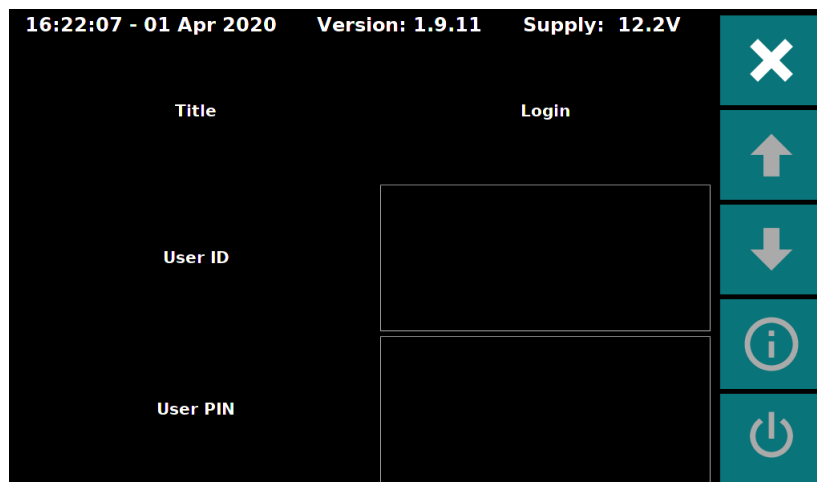

Figure 6.1: Settings - Login

Tap in the desired user ID from Table 6.1 and press the enter button (">") on the bottom right of the keypad.

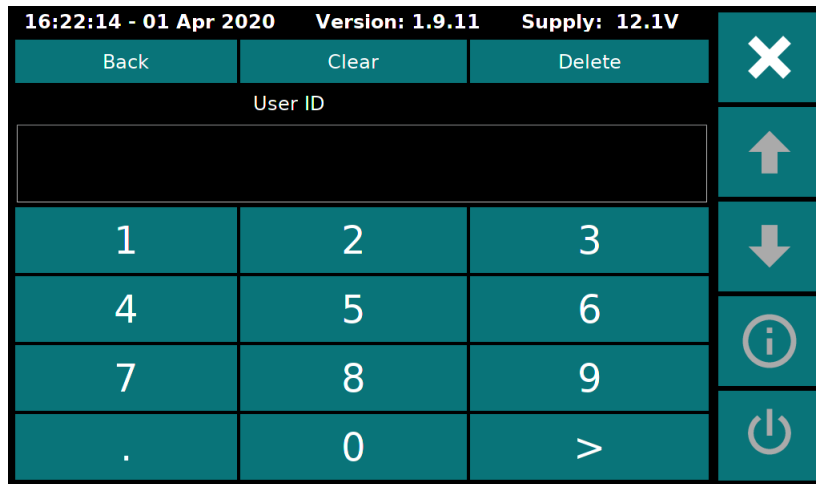

Figure 6.2: Settings - Keypad

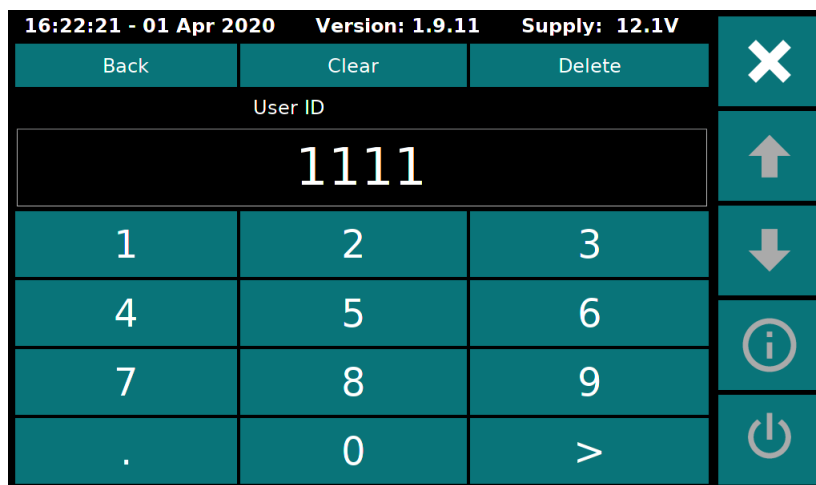

Figure 6.3: Settings - Enter User ID

## 6.2 Settings Menus

The following subsections list each of the menu pages. These menus can be cycled through by clicking the up and down arrows after logging in.

### 6.2.1 General Settings

The general settings page is for configuring the basic operation of the instrument.

Table 6.3: General Settings

Setting	Options	Details
Detector Layout	H/F	Hand and Foot Detectors
	H/F/Fr	Hand, Foot, and Frisker Detectors
	H/H/F	Hand, Hand, and Foot Detectors
	Fr	Frisker Detector
Alpha/Beta Display	Alpha/Beta	Display alpha and beta readings
	Alpha only	Display only alpha readings
	Beta only	Display only beta readings
Idle/Frisk Units	CPM	Counts Per Minute
	CPS	Counts Per Second
	DPM	Disintegrations Per Minute
	Bq	Becquerels
Count Units	CPM	Counts Per Minute
	CPS	Counts Per Second
	DPM	Disintegrations Per Minute
	Bq	Becquerels
	Counts	Total Counts
	Disintegrations	Total Disintegrations
Disable Mute Button	Check Box	If checked, mute button cannot be manually toggled.
Disable Background Subtract Button	Check Box	If checked, background subtract button cannot be manually toggled.
Disable Mode Button	Check Box	If checked, mode button cannot be manually toggled.
Disable Cradle Mute	Check Box	If checked, device will not mute when frisker is placed back into cradle.
Settings Pin	Integer	PIN number is required to access settings.
Source Check PIN	Integer	PIN number is required to perform source check.

## 6.2.2 Idle Settings

These settings control how the unit operates while idle.

Table 6.4: Idle Settings

Setting	Options	Details
Idle/Frisk Units	CPM	Counts Per Minute
	CPS	Counts Per Second
	DPM	Disintegrations Per Minute
	Bq	Becquerels
Idle Display	Background	Show 5-minute background average in rate units while idle.
	Rate	Show rate mode readings while idle.
Idle Rate Alarm Mode	Net	Idle alarm point is based on live rate value minus background.
	Gross	Idle alarm point is based on live rate value.
Enable Audio Alarm While Idle	Check Box	Audio alarm will sound while idle.



The units for the alarm points are controlled by the detector board's rate mode settings.

### 6.2.3 MCT Settings

The minimum count time (MCT) function is controlled with the following settings.



Minimum count time is currently unavailable on the Model 3277/1. This menu will probably be removed in a future update.

Table 6.5: MCT Settings

Setting	Options	Details
Count Units	CPM	Counts Per Minute
	CPS	Counts Per Second
	DPM	Disintegrations Per Minute
	Bq	Becquerels
	Counts	Total Counts
	Disintegrations	Total Disintegrations
Confidence	<percentage>	Selects confidence required for calculating minimum count time.
Min MCT Time	Integer	Minimum allowed MCT count seconds.
Max MCT Time	Integer	Maximum allowed MCT count seconds.
Auto Activate BG Subtract	Checkbox	Allows Background Subtract to automatically activate.
MCT Alarm Mode	Net	MCT alarm point is based on live rate value minus background.

### 6.2.4 Manual Count Settings

These settings offer more options related to Manual Count Mode.

Table 6.6: Manual Count Settings

Setting	Options	Details
Count Units	CPM	Counts Per Minute
	CPS	Counts Per Second
	DPM	Disintegrations Per Minute
	Bq	Becquerels
	Counts	Total Counts
	Disintegrations	Total Disintegrations
Manual Count Alarm Mode	Net	Manual count alarm point is based on live rate value minus background.
	Gross	Manual count alarm point is based on live rate value.

### 6.2.5 Frisk Settings

These settings control how the unit operates while in Frisk mode.

Table 6.7: Frisk Settings

Setting	Options	Details
Idle/Frisk Units	CPM	Counts Per Minute
	CPS	Counts Per Second
	DPM	Disintegrations Per Minute
	Bq	Becquerels
Auto Activate BG Subtract	Checkbox	Allows Background Subtract to automatically activate.
Frisk Alarm Mode	Net	Frisk alarm point is based on live rate value minus background.
	Gross	Frisk alarm point is based on live rate value.

### 6.2.6 Source Check Settings

The source check menu controls how the source check functions.

Table 6.8: Source Check Settings

Setting	Options	Details
Source Check Count Time	Integer	Number of seconds to count for each source check test.
Combine Alpha/Beta Sources	Checkbox	Count both alpha and beta sources for each source test.
Source Check Expiration Mode	Disabled	Source check is not active.
	Time of Day	Source Check will expire at the 24-hour format time of day defined by "Source Check Expiration Hours."
	X Hours	Source Check will expire in the number of hours defined by "Source Check Expiration Hours."
Source Check Expiration Hours	Float	Hour value used for the "Source Check Expiration Mode."

Example: Enable the source check with 10-second counts and have it expire at 6:30 pm every day. Set the following:

Setting	Value
Source Check Count Time	10
Source Check Expiration Mode	Time of Day
Source Check Expiration Hours	18.5

### 6.2.7 Set Time

This menu is for setting the time.



If a change in date causes a change into or out of daylight savings time, a reboot is recommended after setting the time.

Table 6.9: Set Time

Setting	Options	Details
Time Zone	<Time zones>	Time zone options will vary depending on daylight savings
Hours	Integer	Current time of day in hours (24-hour format)
Minutes	Integer	Current time of day in minutes
Month	Integer	Current month of the year
Day	Integer	Current day of the month
Year	Integer	Current year
Set Time	Go Button	Pressing button sets the system time and time zone to the current settings

### 6.2.8 Calibration Settings

This menu is for setting calibration settings for each detector.



Table 6.10: Calibration Settings

Setting	Options	Details
Hand Firmware	String	Detector's Firmware Version
Device SN	String	Device's Serial Number
Detector SN	String	Detector's Serial Number
Voltage	Integer	Detector's Voltage
Overload	Integer	Detector's Overload Value
Alpha/Beta Threshold	Float	Detector's Alpha or Beta Threshold
Alpha/Beta Window	Float	Detector's Alpha or Beta Window
Alpha/Beta Efficiency	Integer	Detector's Alpha or Beta Efficiency

## 6.3 Info Menu

This menu can be accessed by clicking on the info icon.

Table 6.11: Info

Setting	Options	Details
Hostname	<read only>	The name used by this device when connected to the network
IPv4	<read only>	IP address of this device when connected to the network
Upgrade	Web Button	Pressing button will attempt to download and install an update over the internet
Web Server	Start Button	Pressing button will start the maintenance web server



The instrument will attempt to get an IP address via DHCP when it boots up. It is recommended to reboot the instrument if the networking state is changed.



For the self upgrade to work, the instrument must be connected to the network and allowed to access the internet.



For security reasons, the web server is not running on boot. Therefore you will need to manually start it via the settings menu button after a reboot.

## 6.4 System Control Menu

This menu is for safely shutting down and rebooting the system.



It is recommended to always power off the instrument by performing a shutdown sequence. Failure to follow this may corrupt the operating system.

Table 6.12: System Control

Setting	Options	Details
Reboot	Go Button	Pressing button will immediately reboot system
Shutdown	Go Button	Pressing button will immediately shut down system



If your model is equipped with a power switch, turning the switch to the off position should start a shutdown without using this menu. If a shutdown is performed from this menu, the switch will have to be turned off then back on to power up the instrument again.

## DETECTOR BOARD CALIBRATION/CONFIGURATION

The Model 3277/1 utilizes Model 3002 main boards to power the detectors. The application processor in the Model 3277 communicates with each of these "detector boards" (Model 3002 boards) to get readings. All calibration information is stored in the detector boards.

Calibration can be accomplished with Ludlum's LUMIC Calibration software. Each detector board will need to be connected via the USB port (Figure 7.1) to a computer running LUMIC Calibration.

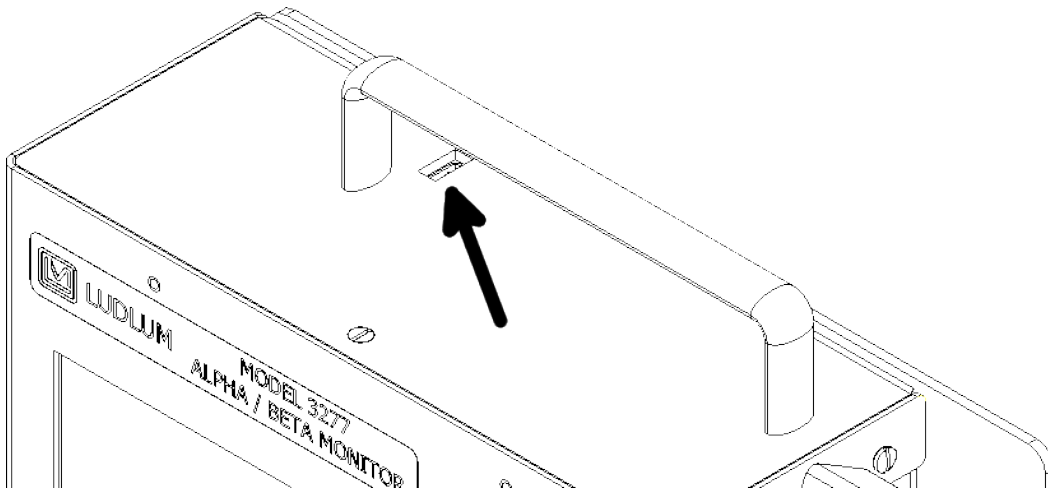

Figure 7.1: Calibration Port

### 7.1 Required for operation

Table 7.1 describes the parameters every detector board (Model 3002 board) must be configured to for proper operation of the Model 3277/1. These should all be set correctly at the factory and are listed here for reference.

Table 7.1: Required Parameter Settings

Parameter	Value	Reason
AuxCom Enable	1	Enables the Aux Comm port on the Model 3002
AuxCom Mode	1	Set communication mode to "LMI Comm Direct"
AuxCom Power Mode	0	Turn on Aux Comm port on power up
AuxCom Auto Off Time	0	Do not automatically turn off Aux Comm port
AuxCom Write Protect	0	Allow incoming commands from the Model 3277/1

## 7.2 Calibration Parameters

Table 7.2 lists the parameters that need to be configured for proper calibration. These parameters must be set via Lumatic Calibration Software.

Table 7.2: Calibration Parameters

Parameter	Effect
High Voltage	Sets the operating voltage of the detector
Thresholds & Windows	Sets the discrimination voltages for the alpha and beta channels
Efficiency	Defines the detection efficiency of the detector
Rate Units	Defines the unit shown while the Model 3277/1 is idle in the "Rate" mode <sup>1</sup>
Count Units	Defines the unit shown while in all "Counting" modes <sup>2,3</sup>
Rate Alarm	Alarm value while the Model 3277/1 is idle in the "Rate" mode <sup>4</sup>
Count Alarm	Alarm value while the Model 3277/1 is in all "Counting" modes <sup>4</sup>
Loss of Count Time	Number of seconds with 0 counts before a "LOC" error
Count Time	Number of seconds for a manual count (has no affect on MCT count times)

<sup>1</sup> Rate units for all detectors must be set to the same unit type

<sup>2</sup> Count units for all detectors must be set to the same unit type

<sup>3</sup> For MCT use, count units must be of rate type (cpm, cps, dpm, or dps)

<sup>4</sup> See subsection 7.2.2 for more information

### 7.2.1 Idle Alarm Values

Alarms for "Idle" mode are set via the the settings menu. This applies to both "Idle Background" and "Idle Rate." See subsection 6.2.2 for more details.

### 7.2.2 Rate and Count Alarm Values

This value is the alarm value reference for "Rate" mode and all "Counting" modes in normal operation. It does not apply to "Idle" modes or source check. It is always relative to the value shown on the display. If background subtract is off, the alarm is effectively applied to the gross counts (Figure 7.2). If background subtract is on, the alarm is compared to the net counts (Figure 7.3).

<i>BackgroundSubtract</i>	<i>Off</i>
$CPM_{Alarm}$	= 100
$CPM_{Gross}$	= 100
$CPM_{Background}$	= 10
$CPM_{Net}$	N/A
<hr/>	
$CPM_{OnDisplay}$	= 100
<i>Alarming</i>	<i>Yes</i>

Figure 7.2: Count Alarm Example - Background Off

<i>BackgroundSubtract</i>	<i>On</i>
$CPM_{Alarm}$	= 100
$CPM_{Gross}$	= 100
$CPM_{Background}$	= 10
$CPM_{Net}$	= 90
<hr/>	
$CPM_{OnDisplay}$	= 90
<i>Alarming</i>	<i>No</i>

Figure 7.3: Count Alarm Example - Background On

### 7.2.3 Ignored Parameters

Table 7.3 lists the parameters that are ignored and/or overridden by the Model 3277/1.

Table 7.3: Ignored Parameters

Parameter	Value	Reason
Response Time	0	Always in auto response rate
AutoResponse	Varies	With the frisker in the cradle (if equipped), the auto response rate is " <b>Slow</b> " If the frisker is removed from the cradle, the auto response rate is " <b>Fast</b> "
Device Display Controlled Audio	Off	The Model 3277/1 controls sets this to ensure alpha and beta pulse are heard



## SPECIFICATIONS

### 8.1 Model 3277/1 System

#### Part Number 48-4357

- **DISPLAY:** 17.8 cm (7 in.) diagonal, TFT LCD SVGA
- **COUNT TIME:** manual count mode
- **CONTROLS:** touch screen
- **ALARMS:** audible and visual alarms
- **LINEARITY:** within 10%
- **CLICK AUDIO:** greater than 75 dB at 0.6 m (2 ft.), approximately 4.5 kHz
- **ALARM AUDIO:** greater than 100 dB at 0.6 m (2 ft.), approximately 2.9 kHz
- **TEMPERATURE RANGE:** 0 to 40 °C (32 to 104 °F)
- **POWER:** 100-240 Vac wall transformer, main electronics 9-15 Vdc, 15W
- **INTERNAL BATTERY:** 12 V, 6 A·hr provides up to 8 hours run time
- **CONSTRUCTION:** aluminum with powder-coat finish
- **SIZE:** 9.4 x 18.5 x 23.6 cm (3.7 x 7.3 x 9.3 in.)
- **WEIGHT:** 4.7 kg (10.4 lb)

- **CONFIGURATION OPTIONS:**

- **Desktop Mount:** PN 4519-277
- **Wall Mount:** PN 4519-439
- **Model 43-93 Cradle:** PN 4519-441
- **Model 43-147 Cradle:** PN 4519-442

- **COMPATIBLE DETECTORS:**

- **Model 43-93:** (PN: 47-2556) 100 cm<sup>2</sup> alpha/beta scintillator
- **Model 43-147:** (PN: 47-4092) 200 cm<sup>2</sup> alpha/beta scintillator
- **Model 43-68:** (PN: 47-2005) 100 cm<sup>2</sup> alpha/beta gas proportional



## REVISION HISTORY

This section of the manual will be updated with each revision of the Model 3277/1 in order to document changes over time. Ludlum Measurements' policy is to provide free software upgrades to instruments for the life of the instrument.

**August 2020:** New manual.

**October 2020:** Updated Firmware to Firmware 1.10.2. Updated Section 2.1.1 Power the Unit. Updated Section 2.8 Backup Battery. Added Section 3 Normal Operation. Added Section 6 Settings.

**April 2021:** Updated firmware. Added Appendix A Drawings section with Drawings 519 x 255M Frisking Mount Options and Drawing 519 x 429H Hole Template.

**August 2023:** Updated in Chapter 2 and Chapter 4 on how to remove and connect battery. Added Linearity to Chapter 8 Specifications. Updated Drawing 519 x 429H.

**January 2024:** Updated firmware to Version 1.10.4. Updated Chapter 6 Settings by updating General Settings, Idle Settings, MCT Settings, and Source Check Settings. Added sections and tables for Manual Count Settings, Frisk Settings, and Calibration Settings.



## RECYCLING

Ludlum Measurements, Inc. supports the recycling of the electronics products it produces for the purpose of protecting the environment and to comply with all regional, national, and international agencies that promote economically and environmentally sustainable recycling systems. To this end, Ludlum Measurements, Inc. strives to supply the consumer of its goods with information regarding reuse and recycling of the many different types of materials used in its products. With many different agencies – public and private – involved in this pursuit, it becomes evident that a myriad of methods can be used in the process of recycling. Therefore, Ludlum Measurements, Inc. does not suggest one particular method over another, but simply desires to inform its consumers of the range of recyclable materials present in its products, so that the user will have flexibility in following all local and federal laws.

The following types of recyclable materials are present in Ludlum Measurements, Inc. electronics products, and should be recycled separately. The list is not all-inclusive, nor does it suggest that all materials are present in each piece of equipment:

Batteries	Glass	Aluminum and Stainless Steel
Circuit Boards	Plastics	Liquid Crystal Display (LCD)

Ludlum Measurements, Inc. products that have been placed on the market after August 13, 2005, have been labeled with a symbol recognized internationally as the “crossed-out wheelie bin,” which notifies the consumer that the product is not to be mixed with unsorted municipal waste when discarding. Each material must be separated. The symbol will be placed on outside of the instrument.

The symbol appears as such:





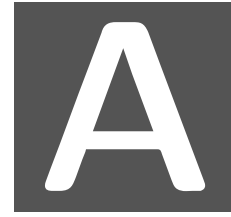

## DRAWINGS

Drawing	Description	Page
519 x 255M	Frisker Mounting Options	50
519 x 429H	M3277/1 Hole Template	51

REVISION HISTORY			
REV	DESCRIPTION	DATE	BY
1	VALID	9/25/19	DLJ

POSITION 1

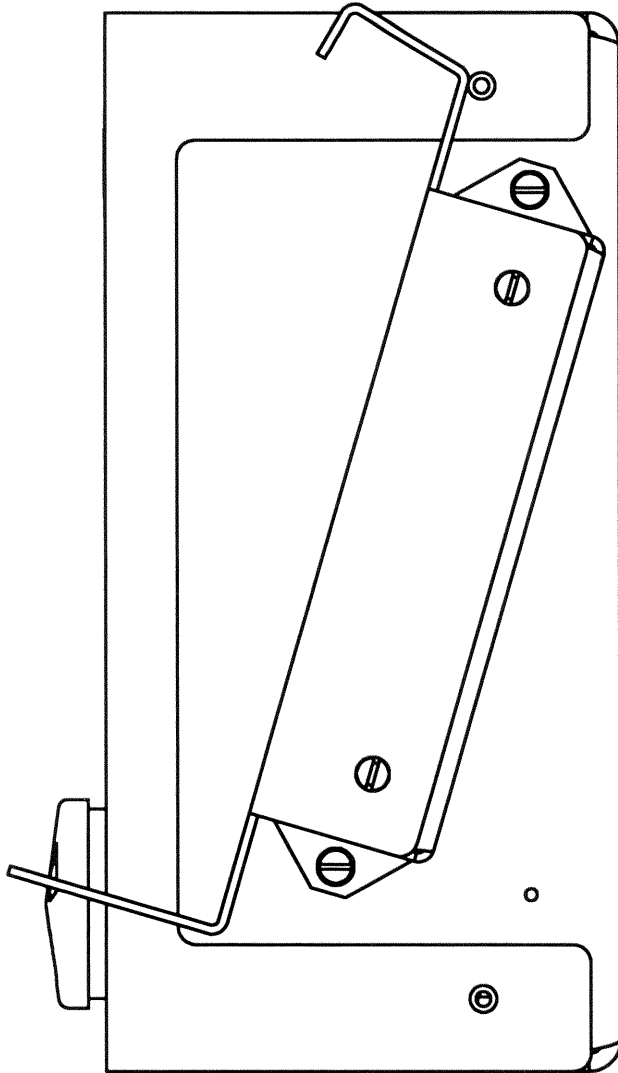

POSITION 2

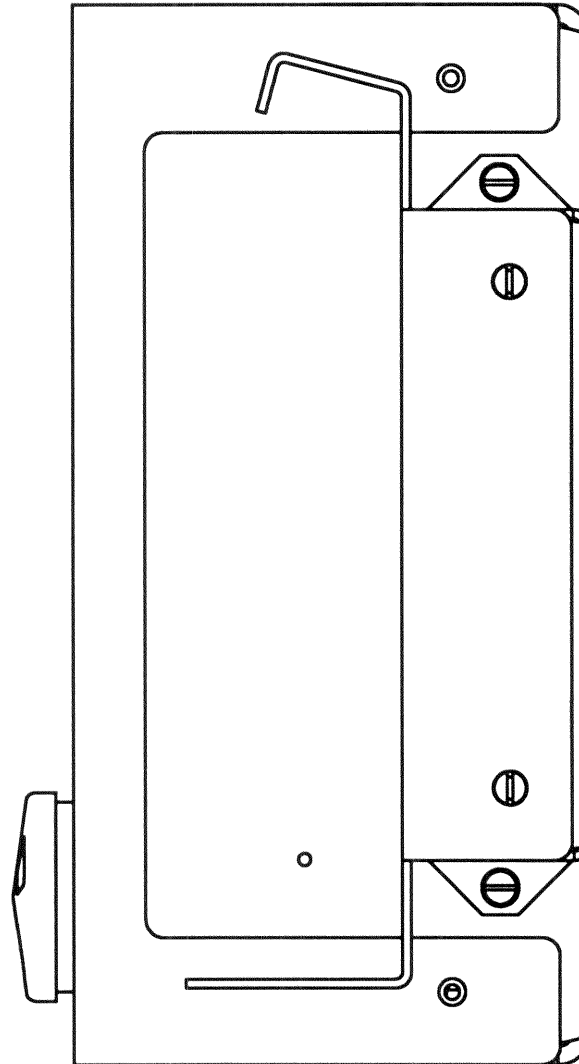

FRISKER OPTION HAS 2 OPTIONS.  
WHEN ELECTRONICS ARE  
VERTICAL OR MOUNTED ON A  
WALL, POSITION 1 IS  
RECOMMENDED.

WHEN ELECTRONICS ARE AT AN  
ANGLE, POSITION 2 IS  
RECOMMENDED.

DWN	DATE	CHK	DATE	APP	DATE
DLJ	9/25/19			DLJ	9-25-19
<b>DWG NUM:</b> 4519-255				<b>SCALE:</b>	
<b>TITLE</b> FRISKER MOUNTING OPTIONS					
 <b>LUDLUM</b> MEASUREMENTS, INC. 501 OAK STREET SWEETWATER, TEXAS 79556			<b>SERIES</b> 519	<b>SHEET</b> 255M	

REVISION HISTORY			
REV	DESCRIPTION	DATE	BY
1	VALID	3/10/20	DLJ
2	ADDED EXTERNAL FUSE ECF 5275	1/13/22	DLJ
3	UPDATED	08/03/23	ABM

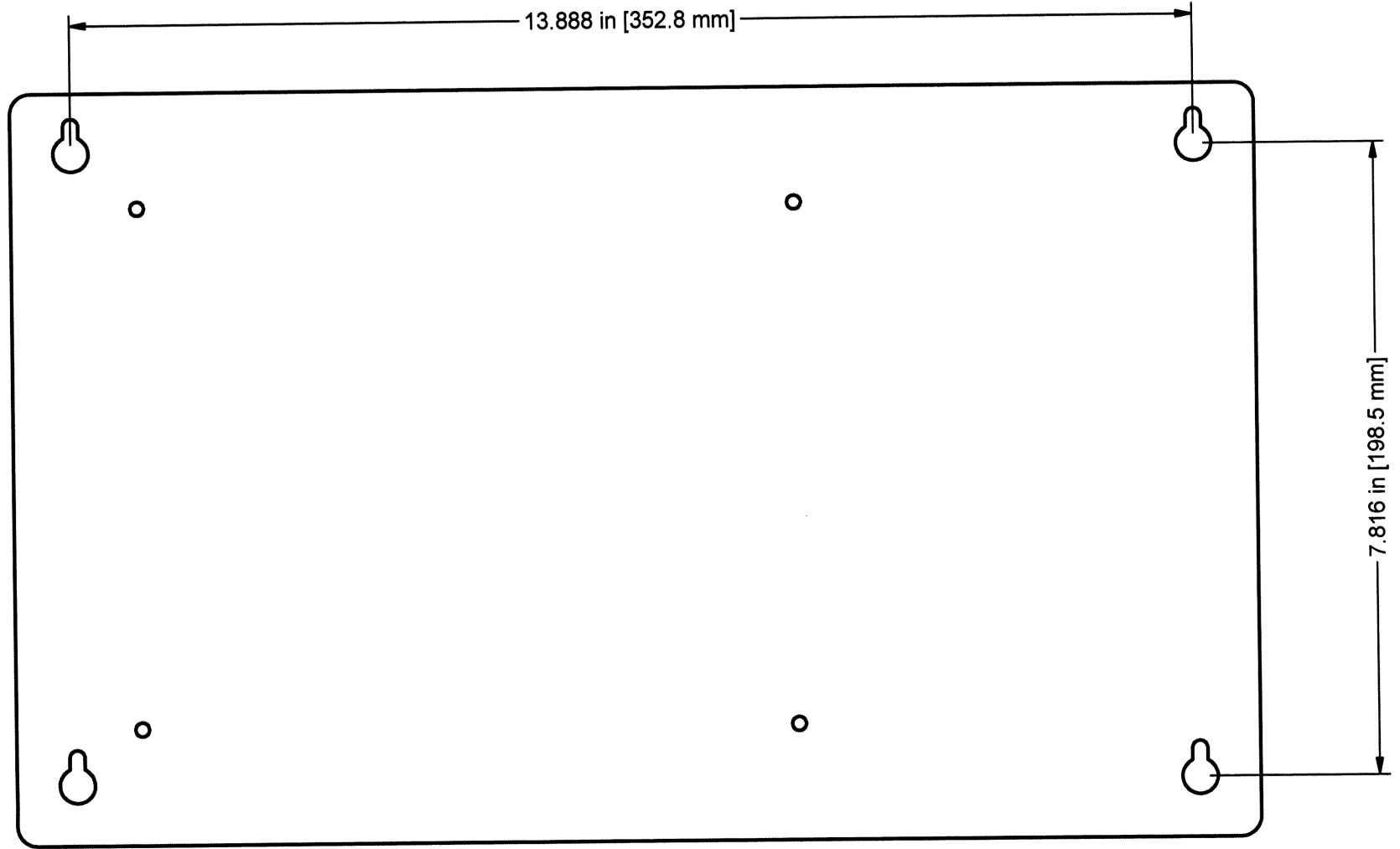

SIZE #6 OR #8 SCREW (3.5 OR 4 mm) WITH A BUTTON OR PAN HEAD.  
 SCREW TYPE DEPENDS ON WALL CONSTRUCTION

DWN	DATE	CHK	DATE	APP	DATE
ABM	08/03/23			<i>ABM</i>	<i>8-14-23</i>
<b>DWG NUM: 4519-429</b>				<b>SCALE: 1/2</b>	
<b>TITLE M 3277/1 HOLE TEMPLATE</b>					
 LUDLUM MEASUREMENTS, INC. 501 OAK STREET SWEETWATER, TEXAS 79556			SERIES	SHEET	
			519	429H	