

---

**LUDLUM MODEL 177  
ALARM RATEMETER**

**November 2010**

**Serial Number 121166 and Succeeding  
Serial Numbers**

**Legacy Version**

---

**LUDLUM MODEL 177  
ALARM RATEMETER**

**November 2010**

**Serial Number 121166 and Succeeding  
Serial Numbers**

**Legacy Version**



**LUDLUM MEASUREMENTS, INC**  
501 OAK STREET, P.O. BOX 810  
SWEETWATER, TEXAS 79556  
325-235-5494, FAX: 325-235-4672



REV #	ALTERATIONS	DATE	BY
1	VALID	8/8/91	BK
2	ADDED SYMBOLS	12/7/05	CMC

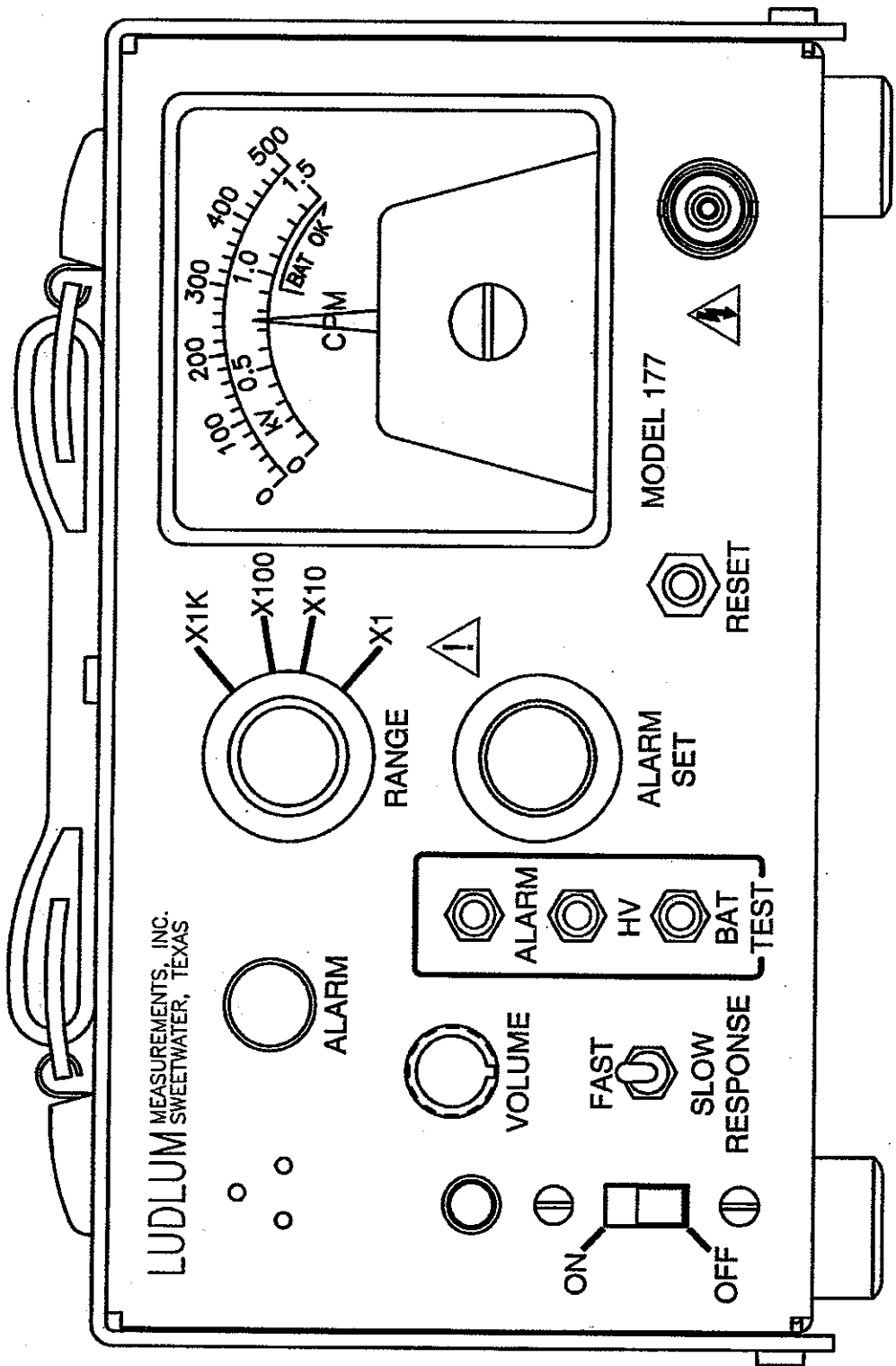

LUDLUM MEASUREMENTS, INC.  
SWEETWATER, TEXAS

MODEL 177

DWG DATE	CHK	DATE	REV
CMC	12-7-05	12/6/05	05
DWG NUM#	4347-186	SCALE	FULL OTHER
TITLE M 177 ALARM RATEMETER			
LUDLUM MEASUREMENTS, INC. 500 ONE STREET SWEETWATER, TEXAS 75086			SHEET
			26

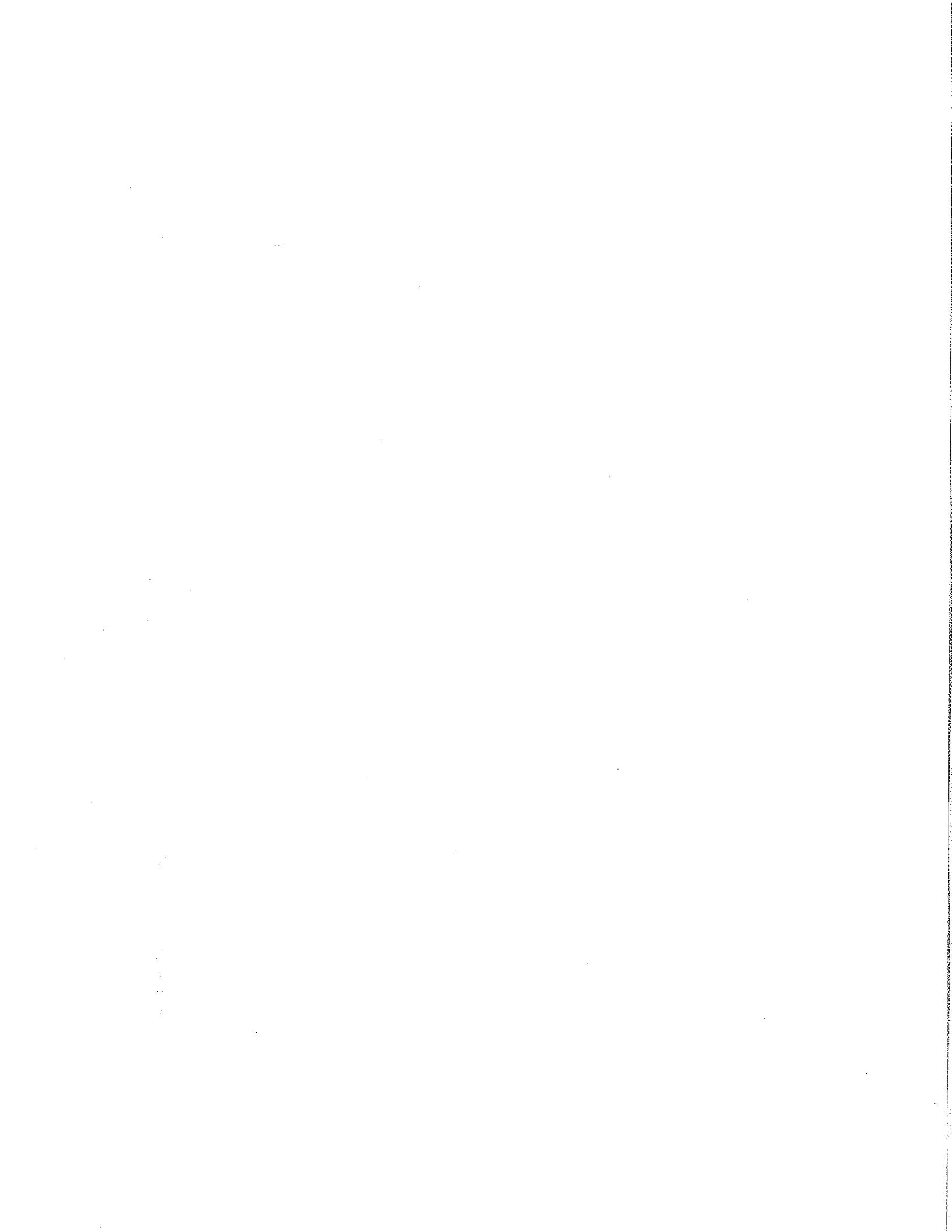

REV #	ALTERATIONS	DATE	BY
1	VALID	8/8/91	BK
2	ADDED SYMBOLS	12/7/05	CMC

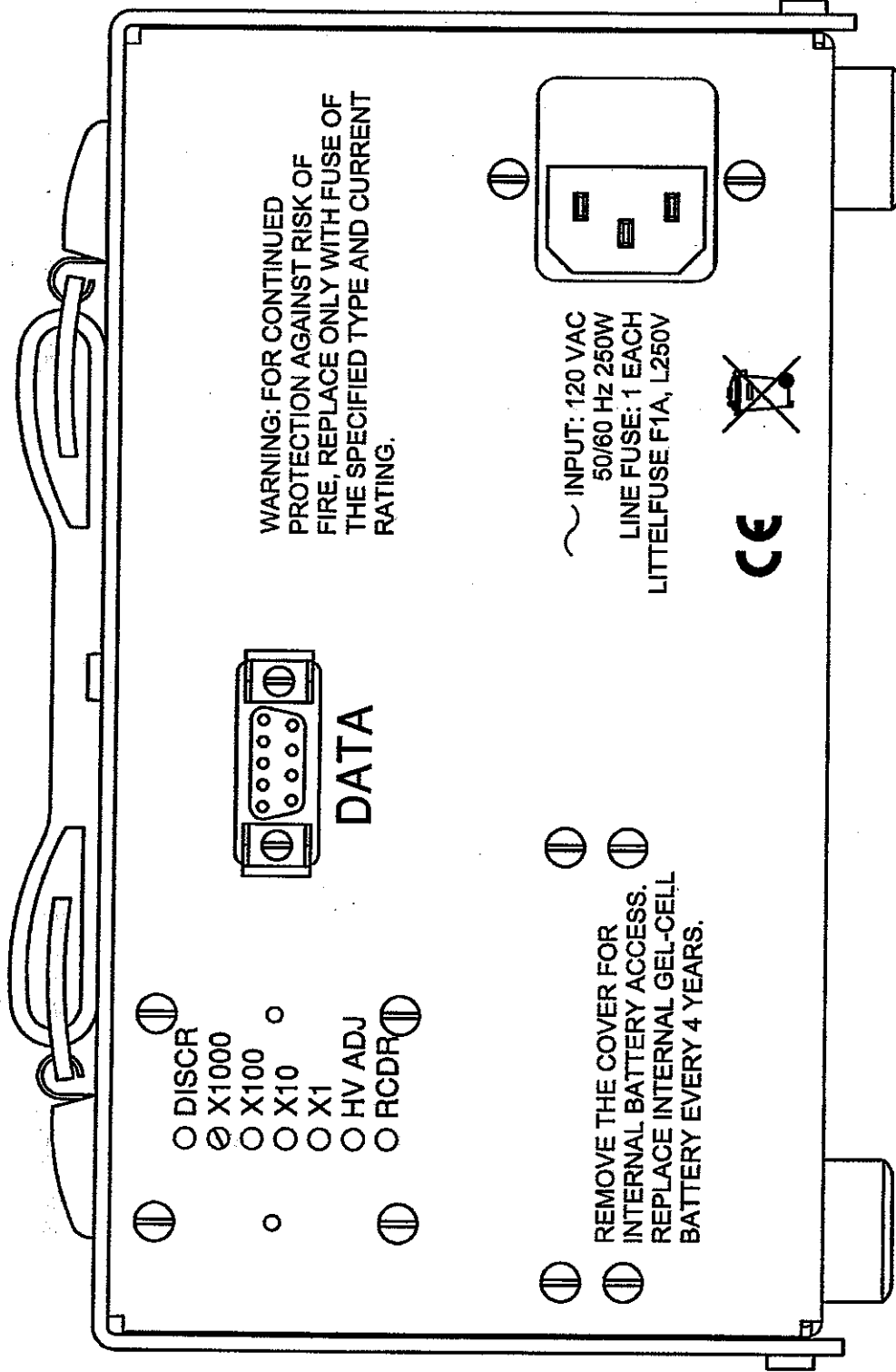

WARNING: FOR CONTINUED PROTECTION AGAINST RISK OF FIRE, REPLACE ONLY WITH FUSE OF THE SPECIFIED TYPE AND CURRENT RATING.

INPUT: 120 VAC  
50/60 Hz 250W  
LINE FUSE: 1 EACH  
LITTELFUSE F1A, L250V



- DISCR
- X1000
- X100
- X10
- X1
- HV ADJ
- RCDR

REMOVE THE COVER FOR INTERNAL BATTERY ACCESS.  
REPLACE INTERNAL GEL-CELL BATTERY EVERY 4 YEARS.

DATE	CHK	DATE	DATE
CMC	12/7/05	AS	12/7/05
DWG NUM	4347-186	SCALE	FULL
TITLE	M 177 ALARM RATE METER	SHEET	26A
LUDLUM INSTRUMENTS, INC.		SERIES	347
200 W. 17TH STREET			
BOSTON, MASS. 02116			

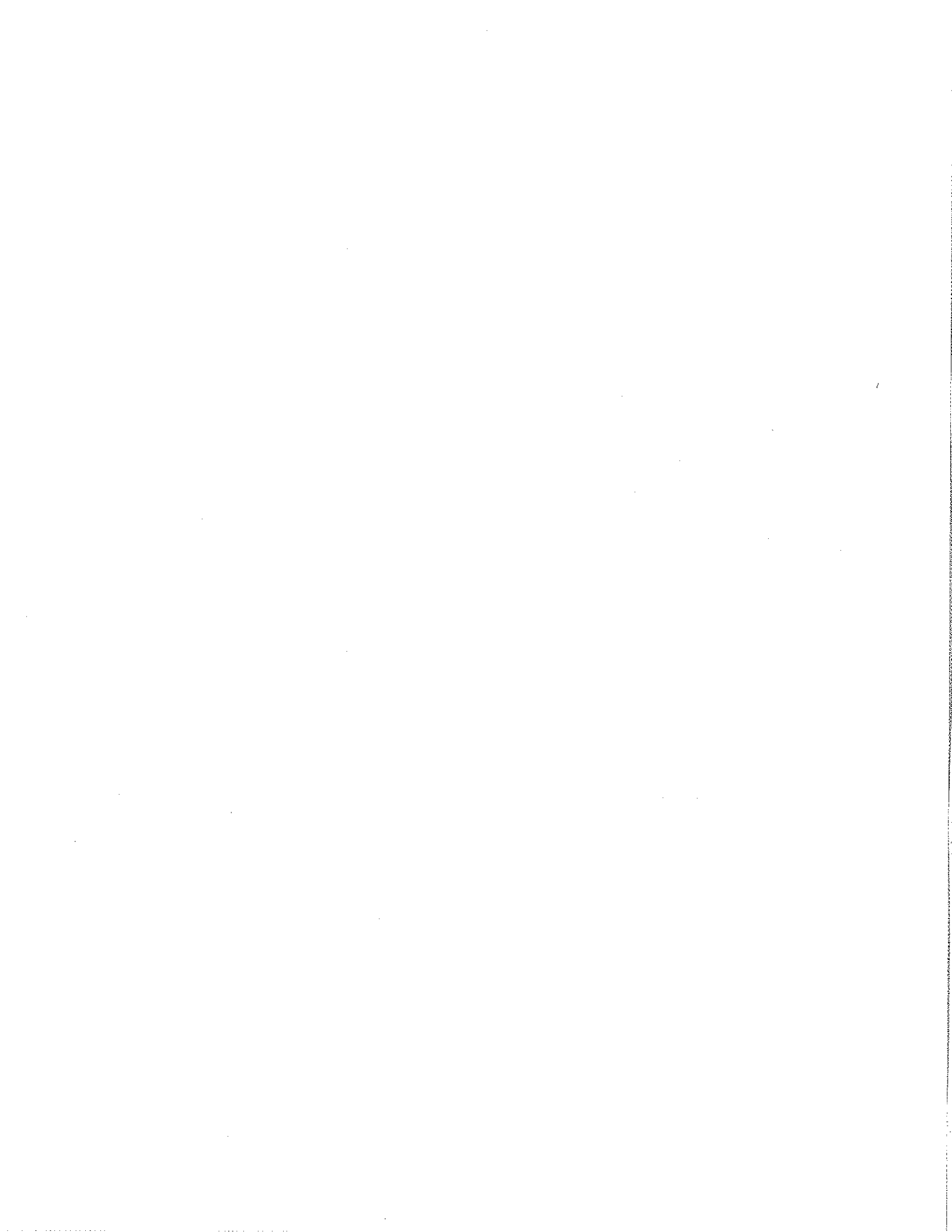

# Table of Contents

---

<b><i>Introduction</i></b>	<b>1</b>
<b><i>Getting Started</i></b>	<b>2</b>
Preparing the Instrument for Use	2-1
Operating the Instrument	2-1
<b><i>Specifications</i></b>	<b>3</b>
<b><i>Description of Controls and Functions</i></b>	<b>4</b>
Front Panel	4-1
Back Panel	4-2
CAL Control	4-3
Internal Controls (Overhaul Only)	4-4
<b><i>Safety Considerations</i></b>	<b>5</b>
Environmental Conditions for Normal Use	5-1
Cleaning Instructions and Precautions	5-1
Warning Markings and Symbols	5-2
Replacement of Main Fuse	5-3
<b><i>Calibration and Maintenance</i></b>	<b>6</b>
Calibration	6-1
Establishing an Operating Point	6-2
Maintenance	6-3
<b><i>Troubleshooting</i></b>	<b>7</b>
Troubleshooting Electronics that utilize a G-M, or Scintillation Detector	7-1
Troubleshooting G-M Detectors	7-2
Troubleshooting Scintillators	7-3
<b><i>Technical Theory of Operation</i></b>	<b>8</b>
Amplifier	8-1
Discriminator	8-1
Digital Analog Conversion	8-1
Time Constant	8-2



<b>Alarm</b>	<b>8-2</b>
<b>Reset</b>	<b>8-2</b>
<b>Audio</b>	<b>8-2</b>
<b>High Voltage (HV)</b>	<b>8-3</b>
<b>Low Voltage</b>	<b>8-3</b>
<b>Battery Charge</b>	<b>8-3</b>
<b>High Voltage Test</b>	<b>8-3</b>
<b>Alarm Set Voltage</b>	<b>8-3</b>
<b>Battery Test Voltage</b>	<b>8-4</b>
<b><i>Recycling</i></b>	<b>9</b>
<b><i>Parts List</i></b>	<b>10</b>
<b>Model 177 Alarm Ratemeter</b>	<b>10-1</b>
<b>Main Board, Drawing 347 × 227</b>	<b>10-1</b>
<b>Calibration Board, Drawing 347 × 132</b>	<b>10-4</b>
<b>Wiring Diagram, Drawing 347 × 230</b>	<b>10-5</b>
<b><i>Drawings and Diagrams</i></b>	<b>11</b>

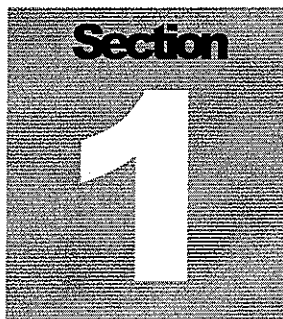

## Introduction

---

The Ludlum Model 177 Alarm Ratemeter may be used with GM (Geiger-Mueller) or scintillation detectors for contamination monitoring, surveying and area monitoring. The unit provides four ranges (in decades) of the analog meter, enabling measurement from 0 to 500,000 counts per minute (CPM) on the standard meter dial; others are available. Detector high voltage is adjustable from 200 to 1500 volts.

The unit incorporates an adjustable alarm set point. The alarm setting may be checked by depressing the front panel TEST switch. Audible and visual enunciators are triggered when the meter reading rises above the alarm set point. Accessory outputs include: Unbuffered Output, Supply Voltage, Negative Pulse Output, Recorder and Alarm Sink for Remote Relay. The unit may be operated from an internal rechargeable battery or by line AC power.

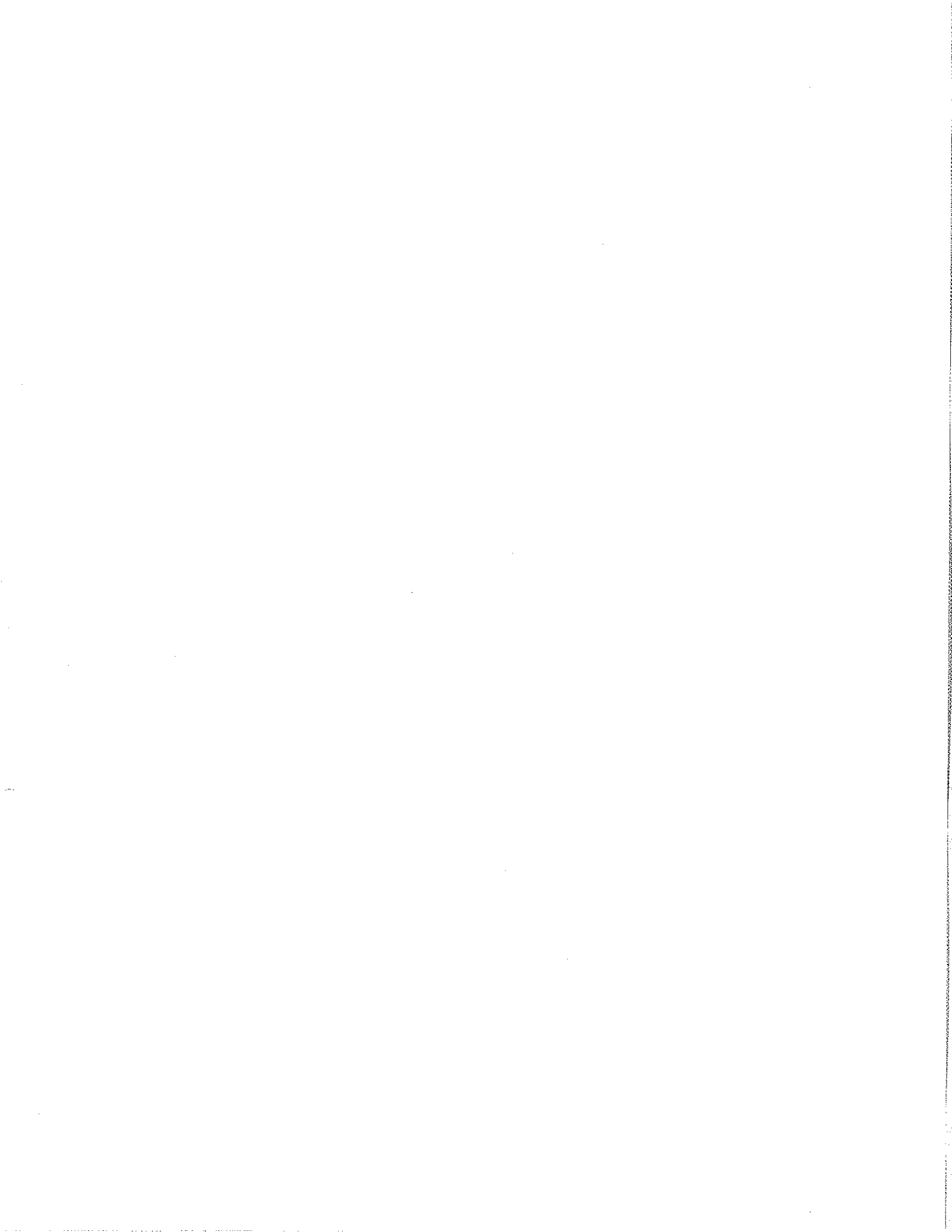

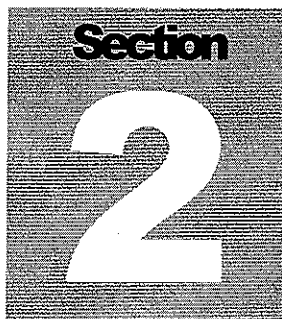
A graphic consisting of a dark, textured square. At the top, the word "Section" is written in a bold, sans-serif font. Below it, a large, white, stylized number "2" is centered within the square.

## Getting Started

---

The Ludlum Model 177 Alarm Ratemeter is designed for use with GM (Geiger Mueller) or scintillation detectors which operate from 200 to 1500 volts. Typical applications include contamination monitoring, surveying and area monitoring.

### Preparing the Instrument for Use

Turn the power switch to the ON position. Depress the BAT TEST button. Check that the meter reads above the BAT TEST indication. If the battery does not check, the instrument will operate on AC line power only. The battery may be trickle-charged from line power or fast-charged from an external source. Connect the instrument to line power if necessary.

Select the operating voltage. This voltage is set by the manufacturer for the detector shipped with the instrument and recorded on the Certificate of Calibration. For other detector/instrument setups, consult the detector manual or manufacturer. Then adjust the HV potentiometer accordingly.

**Note:**

Most GM detectors will operate at 900 volts. However, some smaller GM tubes operate at lower voltages.

### Operating the Instrument

Connect a detector to the instrument. Obtain a meter reading from a check source or calibrated source, if available. Remove the source.

Set the instrument to the appropriate range with the RANGE selector switch.

If the alarm point is not already set, press the ALARM TEST switch and adjust ALARM SET for the desired alarm point.

**Note:**

The meter displays the alarm set point when the ALARM TEST switch is depressed. Recheck the set point after locking the ALARM SET control.

Increase the meter count to exceed the alarm threshold. Both the alarm lamp and audible alarm signal should activate.

Depress the RESET button. The meter needle should drive to zero and the alarm circuit should de-energize, shutting off both the visual and audible alarms.

Depress the HV TEST button and ensure that the high voltage is properly set.

Proceed with use.

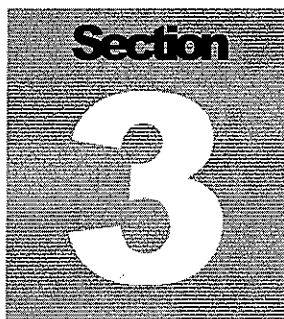

## Specifications

---

**Power:** 95-135 VAC(178-240 VAC available ) (sealed lead-acid) battery. Typical battery life of approximately 50 hours in a non-alarming condition with fully charged battery.

**Fuse:** 1 amp, LITTLEFUSE F1A L250V.

**Response Time:** Two positions: fast 2.2 seconds; slow 22 seconds for 90% of full scale reading.

**Linearity:** Within 10% of full scale. Typically plus or minus 2% of full scale reading when measured with an electronic pulse generator.

**Battery Dependence:** Meter readings vary less than 3% within battery check limits.

**High Voltage:** Variable from 200 to 1500 volts.

**Input Sensitivity:** Adjustable from 10 through 100 millivolts.

**Connector:** Series "C".

**Audio:** Unimorph speaker with volume control located on the front panel.

**Meter:** 1 mA, size: 6.35 x 6.35 cm (2.5 x 2.5 inch)DC movement.

**Meter Scale:** 0-500 CPM; 0-1.5 kV; BAT TEST.

**Ranges:** Four ranges of X1 through X1K.

**Recorder Output:** Correlated to meter reading (adjustable to 1 volt at 1 mA)

**Alarm Output:** Current sink to 200 mA DC. Open circuit voltage not to exceed 50 Vdc.

**Unbuffered Output:** May be used to externally add to or subtract from the meter reading.

**Alarm Range:** Adjustable from 0 through 150% of full scale.

**Alarm Output:** Visual indicator (lamp), audible tone and remote current sink.

**Alarm Control:** Factory set to latching. Non-latching alarm available through the removal of main board resistor R116.

**Finish:** Computer-beige, polyurethane enamel.

**Size:** 15.24 x 20.32 x 12.7 cm (6 x 8 x 5 inch) (D x W x H), excluding handle.

**Weight:** 1.9 kg(4.2 lb) with battery.

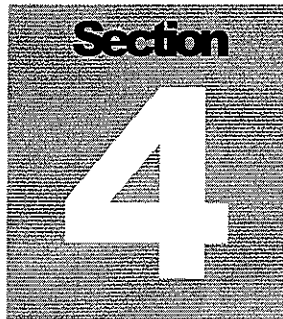
A graphic for Section 4, featuring the word "Section" in a bold, sans-serif font at the top, and a large, white, stylized number "4" centered below it. The background is a dark, textured square.

## Description of Controls and Functions

---

### Front Panel

**Power ON-OFF Switch:** Provides line power of 120 VAC 50/60 Hz to the instrument and trickle-charges the standby battery. In case of line power failure, the battery automatically comes on-line to power the instrument. The battery will provide up to 50 hours of operation.

**Note:**

To recharge the battery, the ON-OFF switch must be in the ON position.

**Power-on Lamp:** A red lamp that comes on when power is supplied to the instrument.

**VOLUME Control:** Varies the volume of the audio output through the unimorph speaker. This control has minimal effect on the audio when the alarm is activated.

**Audio Speaker:** A unimorph speaker, located behind the front panel.

**ALARM Lamp:** A red lamp that comes on when the alarm threshold has been exceeded. The lamp will remain on (unless the alarm is configured to “non-latching”) until the reset button is depressed, driving the meter needle below the alarm threshold.

**RANGE Selector Switch:** A four-position switch providing range multipliers of X1K, X100, X10, and X1. With a scale (meter face) of 0-500 CPM, the full range of the instrument is 0 to 500,000 CPM.

**Ratemeter:** A four-decade linear meter with ranges of 0-500, 0-5000, 0-50,000, 0-500,000 CPM. Other meter faces are available depending on the application. Readout is on a 2.5-inch scale panel meter. A separate scale is provided for battery check and high voltage readout.



**Connector:** Series "C" connector. (Series BNC and MHV connectors are also available). The connector is provided on the front of the instrument for connection to a detector.

**RESET Button:** This button, when depressed, provides a rapid means of driving the meter needle to zero.

**FAST-SLOW RESPONSE Toggle Switch:** When in the FAST position, this switch provides 90% of full-scale meter deflection in 2.2 seconds. With this switch in the SLOW position, 90% of full-scale meter deflection takes 22 seconds. If quick needle response and maximum deviation are desired, the FAST position should be used. For slow response and damped meter movement, the SLOW position should be used.

**BAT TEST Button:** When this button is depressed, the meter displays the battery status. A sufficiently charged battery is indicated when the meter needle is on or within the BAT TEST range.

**HV TEST Button:** When this button is depressed, the meter displays the detector high voltage.

**ALARM TEST Button:** When this button is depressed, the meter displays the alarm calibration set point.

**ALARM SET:** Used to adjust the alarm calibration set point. Note the locking knob below the control.

## Back Panel

**120V AC plug:** Provides power to the instrument from a 120 volts AC, 50/60 Hz, 250W line.

**LINE FUSE:** Provides line protection with a 1 amp fuse- LITTLEFUSE F1A L250V.

**Data:** A 9-pin type "D" data plug with connections as follows:

**PIN 1:** Battery terminal. This is a direct connection and does not go through the front panel ON-OFF switch. Use to parallel battery or use external charger.

**PIN 2:** Unregulated supply from approximately 6 volts, battery only to 9.5 volts with AC power on. Limit current drain to 50 milliamperes.

**PIN 3:** Instrument common (Ground).

**PIN 4:** Alarm sink. The open collector of a 2N7002L. Limits sink current to 200 milliamperes with open circuit voltage limited to a range of 0 to +50 volts. Unit conducts when in alarm.

**PIN 5:** Pulse Out. A negative pulse connected to the discriminator output through a 0.001 uF capacitor. Typically, -4.0 volts.

**PIN 6:** Unbuffered output ties directly to the meter drive circuit. (R124/C122). Approximately 1.3 volts at full scale. Using an external constant current sink will allow background subtract. At full-scale, draws out approximately 3.3 microamperes to zero the meter.

**PIN 7:** Recorder output, adjustable from 0 to 1.0 volts at 1 milliamperes.

**PIN 8 and PIN 9:** Spares

## CAL Control

Remove the calibration (cal) cover plate to access the following calibration potentiometers:

**DISCR:** Discrimination Control. For pancake-type GM detectors (ie. Model 44-9), adjust DISCR for  $80 \pm 10$  millivolts. All other GM detectors and scintillators should be set to  $35 \pm 10$  millivolts. If a lower operating voltage for a scintillator is desired, adjust the discriminator to  $10 \sqrt{2}$  millivolts. This control has an adjustable range of 10 to 100 millivolts. A Ludlum Model 500 Pulser may be used to determine the discrimination level.

**Calibration Controls:** X1K through X1 calibration controls used to calibrate ranges.

**HV ADJ:** Used to set detector operating voltage.

**RCDR:** Used to calibrate the recorder output.

### **Internal Controls (Overhaul Only)**

The following controls are located internally, on the main circuit board:

**BAT C:** Used to adjust charge voltage to 6.825 volts.

**BAT T:** Used to adjust meter test voltage reading to 5.97 volts at the BAT OK line.

**HV T:** Used to adjust the high voltage test reading to correspond with the actual high voltage output.

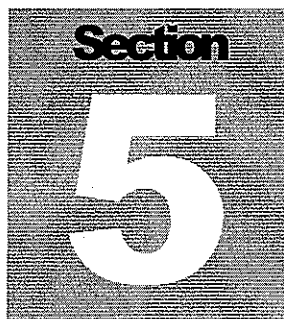

## Safety Considerations

---

### Environmental Conditions for Normal Use

Indoor use only

No maximum altitude

Temperature range of  $-20^{\circ}\text{C}$  to  $50^{\circ}\text{C}$  ( $-4^{\circ}\text{F}$  to  $122^{\circ}\text{F}$ )

Maximum relative humidity of less than 95% (non-condensing)

Mains supply voltage range of 95-135 VAC (178-240 VAC available),  
50/60Hz single phase (less than 100mA)

Maximum transient voltage of 1500 VAC

Installation Category II (Overvoltage Category as defined by IEC 1010-1)

Pollution Degree 1 (as defined by IEC 664).

### Cleaning Instructions and Precautions

The Model 177 Alarm Ratemeter may be cleaned externally with a damp cloth, using only water as the wetting agent. Do not immerse the instrument in any liquid. Observe the following precautions when cleaning:



1. Turn the instrument OFF and disconnect the instrument power cord.
2. Allow the instrument to sit for 1 minute before cleaning.

## Warning Markings and Symbols

### Caution!

The operator or responsible body is cautioned that the protection provided by the equipment may be impaired if the equipment is used in a manner not specified by Ludlum Measurements, Inc.

**The Model 177 Alarm Ratemeter is marked with the following symbols:**

-  **ALTERNATING CURRENT (AC)** (IEC 417, No. 5032) - designates an input receptacle that accommodates a power cord intended for connection to AC voltages. This symbol appears on the back panel.
-  **PROTECTIVE CONDUCTOR TERMINAL** (per IEC 417, No. 5019) – designates the central grounding point for the safety ground. This symbol is visible inside the chassis.
-  **CAUTION** (per ISO 3864, No. B.3.1) – designates hazardous live voltage and risk of electric shock. During normal use, internal components are hazardous live. This instrument must be isolated or disconnected from the hazardous live voltage before accessing the internal components. This symbol appears on the front panel. **Note the following precautions:**

### Warning!

The operator is strongly cautioned to take the following precautions to avoid contact with internal hazardous live parts that are accessible using a tool:

1. Turn the instrument power OFF and disconnect the power cord.
2. Allow the instrument to sit for 1 minute before accessing internal components.



**CAUTION, RISK OF ELECTRIC SHOCK** (per ISO 3864, No. B.3.6) – designates a terminal (connector) that allows connection to a voltage exceeding 1 kV. Contact with the subject connector while the instrument is on or shortly after turning off may result in electric shock. This symbol appears on the front panel.



The “crossed-out wheeled bin” symbol notifies the consumer that the product is not to be mixed with unsorted municipal waste when discarding; each material must be separated. The symbol is placed near the AC receptacle. See section 9, “Recycling” for further information.

## Replacement of Main Fuse (Back Panel)

### **Warning!**

For continued protection against risk of fire, replace only with fuse of the specified type and current rating!

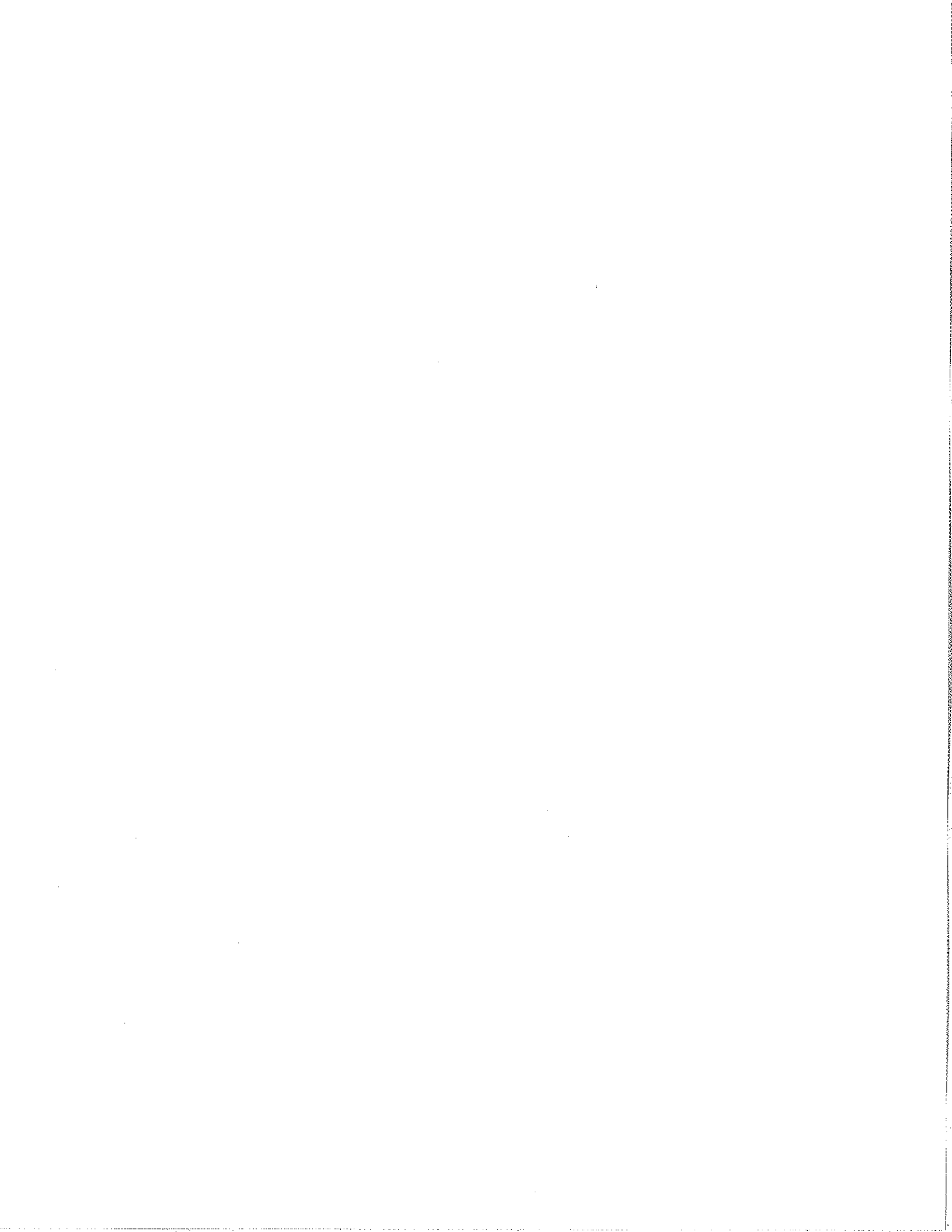

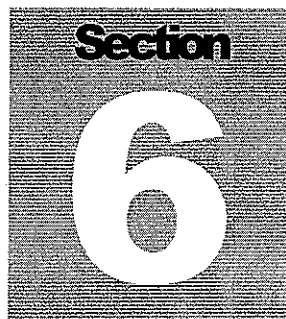
A graphic for Section 6, featuring the word "Section" in a bold, sans-serif font above a large, white, stylized number "6" on a dark, textured background.

## Calibration and Maintenance

### Calibration

**Note:**

Local procedures may supersede the following.

Connect the instrument to a Ludlum Model 500 Pulser (Pulse Generator) or equivalent.

The ratemeter may be calibrated by adjusting the calibration controls labeled 1, 10, 100 and 1K. Starting with the 1000 range, apply 400,000 CPM from Pulser. Adjust the 1K calibration control for a meter reading of 400. Drop the Pulser pulse rate to 100,000 CPM and ensure a meter reading of  $100 \pm 10$ .

Repeat this procedure for the lower scales with scaled pulse rates.

For pancake-type GM detectors (ie. Model 44-9), adjust DISCR for  $80 \pm 10$  millivolts. All other GM detectors and scintillators should be set to  $35 \pm 10$  millivolts. To lower the scintillation detector operating voltage, decrease the input sensitivity to  $10 \pm 2$  millivolts. Adjustment is made by setting the pulse generator amplitude to the desired pulse height. Adjust DISCR until the meter reaches 75% of the generated incoming count rate.

Connect the Model 177 to an external voltmeter. Adjust the rear panel HV control for a reading of 1000 Vdc on the voltmeter. Depress HV TEST. On the main board, adjust HV for a meter reading of 1.0 kV. Using the rear panel HV control, vary the high voltage output from 500 to 1500 Vdc and ensure that the high voltage meter reads within 10% of the Model 177 meter reading.

Adjust RCDR (recorder output) for 1 volt output (equivalent to full scale).

Adjust ALARM SET to the desired set point.



### ***Establishing an Operating Point***

The operating point for the instrument and detectors is established by setting the detector voltage and instrument sensitivity (HV and DIS). The proper selection of this point is the key to instrument performance.

Efficiency, background sensitivity and noise are fixed by the physical makeup of the given detector and rarely vary from unit to unit. However, the selection of the operating point makes a significant difference in the contribution of these three sources of count.

The purpose of setting the operating point is to establish the system gain so that the desirable signal pulses (including background) are above the discrimination level, and the unwanted pulses from noise are below the discrimination level. The pulses above the discrimination level are counted by the instrument, while those below are not.

The total system gain is controlled by adjusting the instrument gain or the high voltage. Voltage affects the output of the detector. Amplifier gain is controlled by the DIS (discriminator) control.

In special cases of GM detectors, a minimum voltage must be applied to establish the Geiger-Mueller characteristic. Further changes in gain will not affect this type of detector.

The operating point for each detector is set at a compromise point between sensitivity, stability and background contribution. These operating points are best for general monitoring. In application, these arbitrarily selected points may not be a better operating point. The following guidelines are presented:

**GM Detectors:** The output pulse height of the GM detector is not proportional to the energy of the detected radiation. Adjusting DIS will have minimal effect on the observed count rate unless the setting is so low that the instrument double pulses.

For most GM detectors, set DIS for 30-40 millivolts and adjust HV to the GM tube recommended high voltage. Most GM detectors operate at 900 volts, however, some miniature detectors operate at 400-600 volts. If a recommended setting is unavailable, run a plateau of HV setting vs. count rate. Then set the high voltage on the low side of "center."

**Scintillators:** Set DIS for 10 millivolts. Carefully increase HV until the instrument plateaus on the background count. This provides the most stable operating point for the detector.

## Maintenance

Instrument maintenance consists of keeping the instrument clean and periodically checking the battery and calibration.

An instrument operational check should be performed prior to each use by exposing the detector to a known source and confirming the proper reading on each scale.

Recalibration should be accomplished after any maintenance or adjustment has been performed on the instrument. Ludlum Measurements recommends recalibration at intervals no greater than one year. Local regulations may have precedence over this recommendation.

To maintain the life of the battery, it is recommended that the instrument be constantly connected to line power with the power switch in the ON position, even when the instrument is not in use. This will keep the internal battery fully charged.

When the instrument is used without line power, adequate charge time must be allowed for the internal battery to recharge. If possible, leave the instrument on with line power applied overnight and weekends. At a minimum, allow one hour of charge time for each hour of use. If the battery is inadvertently allowed to fully discharge, and is left in that state, constant charging for 500 hours (3 weeks) may be required for battery recovery.

### Note:

The ON-OFF switch must be in the ON position to charge the batteries. If the unit is out of service for extended periods of time, charge the battery every 6 months.

It is recommended that the internal GEL-CELL battery be replaced every 4 years.

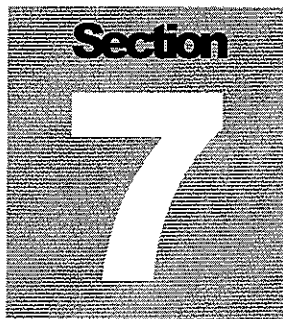

 A graphic for Section 7, featuring the word "Section" in a bold, sans-serif font above a large, white, stylized number "7" set against a dark, textured background.

## Troubleshooting

Occasionally, you may encounter problems with your LMI instrument or detector that may be repaired or resolved in the field, saving turnaround time and expense in returning the instrument to us for repair. Toward that end, LMI electronics technicians offer the following tips for troubleshooting the most common problems. Where several steps are given, perform them in order until the problem is corrected. Keep in mind that with this instrument, the most common problems encountered are: 1. detector cables; 2. sticky meters.

Note that the first troubleshooting tip is for determining whether the problem is with the electronics or with the detector. A Ludlum Model 500 Pulser is invaluable at this point, because of its ability to simultaneously check high voltage, input sensitivity or threshold, and the electronics for proper counting.

We hope these tips will prove to be helpful. As always, please call if you encounter difficulty in resolving a problem or if you have any questions.

### Troubleshooting Electronics that utilize a G-M, or Scintillation Detector

<u>SYMPTOM</u>	<u>POSSIBLE SOLUTION</u>
No power (or meter does not reach BAT TEST or BAT OK mark)	<ol style="list-style-type: none"> <li>1. Check battery and charge if necessary.</li> <li>2. Check for loose or broken wires, especially between the main board and the calibration board.</li> </ol>

<u>SYMPTOM</u>	<u>POSSIBLE SOLUTION</u>
Nonlinear Readings	<ol style="list-style-type: none"><li>1. Check the high voltage (HV) by pressing the HV TEST button. If a Multimeter is used to check the HV, ensure that one with high impedance is used; as a standard Multimeter could be damaged in this process.</li><li>2. Check for noise in the detector cable by disconnecting the detector and placing the instrument on the lowest range setting. Wiggle the cable and observe the reading for significant changes.</li><li>3. Check for "sticky" meter movement. Does the reading change when you tap the meter? Does the meter needle "stick" at any spot?</li><li>4. Check the "meter zero." Turn the power OFF. The meter should come to rest on "0".</li></ol>
Meter goes full-scale or "Pegs Out"	<ol style="list-style-type: none"><li>1. Replace the detector cable to see if it has failed, causing excess noise.</li><li>2. Check the HV and, if possible, the input threshold for proper setting.</li><li>3. Check for loose wires, especially between the main board and the calibration board.</li></ol>

### **Troubleshooting G-M Detectors**

1. If the tube has a thin mica window, check for window breakage. If damage is evident, the tube must be replaced.

2. Check the HV. For most GM tubes, the voltage is normally 900 Vdc, or 460-550 Vdc for "peanut" tubes (Ludlum Model 133 series).
3. If the input sensitivity is too low, the user could see some double-pulsing. See Page 4-3, "DISCR" for further information on sensitivity/discrimination control.
4. Wires to the tube may be broken or the crimped connector could have a loose wire.

## Troubleshooting Scintillators

1. Alpha or Alpha/Beta scintillators are prone to light leaks. They can be tested for this problem in a dark room or with a bright light. If a light leak is determined, changing the Mylar window assembly will usually fix the problem.

### Note:

When replacing the window, make sure to use a window made with the same thickness Mylar and the same number of layers as the original window.

2. Verify that the HV and input sensitivity are correct. Alpha and gamma scintillators typically operate from 10-35 mV. High voltage varies with photomultiplier tubes (PMT), from as low as 600 Vdc, to as high as 1400 Vdc.
3. On a gamma scintillator, visually inspect the crystal for breakage or humidity leakage. Water inside the crystal will turn it yellow and gradually degrade performance.
4. Check the PMT to see if the photocathode still exists. If the end of the PMT is clear (not brownish), this indicates a loss of vacuum which will render the PMT useless.



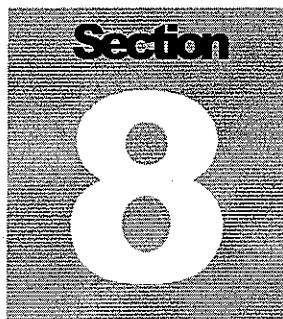

## Technical Theory of Operation

### Amplifier

Negative detector pulses are coupled through C124 to emitter follower Pin U121. R127 protects the input from inadvertent H.V. shorts. R129 couples the detector to the high voltage supply.

Negative pulses from emitter, Pin 2 of U121, are coupled through C121 to amplifier Pin 5 through Pin 7 of U121. This amplifier is self-biased and provides gain in proportion to R029 divided by R0210. Transistor (pins 4-5-6, U121) provides amplification. Pins 12 and 15 of U121 are coupled as a current mirror to provide a load for Pin 6 of U121. The output self-bias to 2 Vbe (approximately 1.4 volts) at Pin 7 of U121. This provides just enough bias current through Pin 6 of U121 to conduct all of the current from the current mirror.

Positive pulses from Pin 7 of U121 are coupled to the discriminator.

### Discriminator

Comparator U021 provides discrimination. The discriminator is set by the DIS (Discriminator) control located on the rear panel, coupled to Pin 5 of U021. Negative pulses (approx. 5 volts) at Pin 7 of U021 are coupled to Pin 5 of U011 for meter drive and Pin 11 of U011 for audio.

### Digital Analog Conversion

Pin 7 of U021 is connected to the dual univibrator, U011. For each low pulse for Pin 7 of U021, Pin 6 of U011 goes high. The pulse of Pin 6 of U011 is typically 5.0 volts for 6 milliseconds on X1 to 6 microseconds on X1k. This pulse is connected to the constant current drive U012. The pulse width control (R3-C2 on calibration board) is utilized for calibration adjustment. Controls R4 through R6 allow calibration on other scales.

For each positive pulse connected to Pin 8 of U012, a constant current pulse is sourced at Pin 15 of U012. This current pulse charges C122, which is



discharged by R124. The average voltage on C122 is coupled through HV, BAT, and ALARM TEST switch to voltage-follower Pin 5 of U311. Pin 7 of U311 drives the meter and recorder output.

## Time Constant

The meter time constant is determined by R124 and C122. For a slower time constant, C122 is paralleled by C101. When C101 is not used, it is connected to Pin 7 of U311 (voltage follower), maintaining the same voltage level as C122. This allows C101 to be switched in or out of the circuit without transients.

## Alarm

An alarm is provided by U021, Pins 1, 2, and 3. The alarm set control biases the op-amp U021 for a low output. When the meter signal at Pin 3 exceeds the bias of Pin 2, the output at Pin 1 goes high. Q102 and Q103 saturate, allowing supply voltage to be coupled to:

Lamp voltage through R004.

Audio Oscillator U16 through CR112.

R116 couples back to Base of Q102, locking up the Alarm On.

Through CR113 to Audio Transformer T211, allowing full voltage for full volume.

Through R111 to saturating current sink Q101 for external use.

## Reset

Reset is provided by coupling a voltage to the base of transistors U012 pins 1, 2, 3, and 4, 5, 6. Both transistors saturate. One discharges C122 causing the meter to zero. Pin 3 U012 turns Q102 off, allowing the alarm to reset.

## Audio

A high on Pin 4 U111 turns the oscillator on saturating Q111 with each positive swing of the oscillator. T211 couples the pulses to the unimorph. Audio volume is controlled by voltage, applied to Pin 2 of T211. This is either 4.3 volts from the alarm circuit or 0 to 4.3 volts from external volume control through emitter follower Q104.

For counting, audio pulse width is set by R113/C111 of U011 with one pulse per count. For an alarm condition, Pin 4 U111 is held high through CR112 until alarm is reset. Alarm audio tone is controlled by R117 and C112.

## High Voltage (HV)

The high voltage power supply is a blocking oscillator utilizing Q401-T411 and quadrupler CR123, CR421, CR422 and through CR423. The HV output is controlled by conduction to ground through Q302. With Q302 saturated, the HV output is maximum.

The op amp, U311 Pins 1, 2, 3, is used as a comparator to compare the voltage reference at Pin 3 to the feedback voltage at Pin 2 through R322 for voltage control and regulation. High voltage is adjusted by HV control R311 changing bias on Pin 2 U311. With the HV control wiper at ground, H.V output is maximum.

## Low Voltage

Low voltage is supplied by internal battery B1 (wiring diagram, 347 × 126) or line power T1. Unregulated power at C125 is coupled to voltage regulator VR211 and battery charger U201-Q301.

Regulated low voltage is supplied to the balance of the circuit through VR131 at 5.0 volts and U301 at 1.2 volts.

## Battery Charge

Battery charge is provided by voltage regulator U201 and power transistor Q301. R402 limits charge current for discharged battery. A negative voltage coefficient of 0-0063 volts per degree F is provided by ratio of R013/R201. R013 set output voltage to 6.825 volts.

## High Voltage Test

High voltage test is supplied by R001 through HV TEST switch, BAT TEST switch, ALARM TEST, Pin 5 of U311, then the meter. The HV readout is calibrated by R001.

## Alarm Set Voltage

Alarm set voltage is coupled from ALARM SET control through the ALARM TEST switch, voltage follower Pin 5 of U311, and to the meter.

## Battery Test Voltage

Battery test voltage is controlled by R002 through BAT TEST switch, ALARM TEST switch, voltage follower Pin 5 of U311 to the meter.

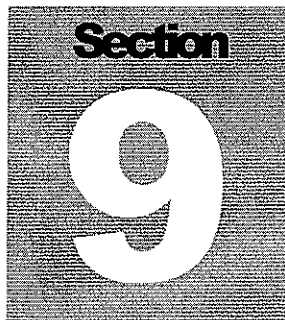
 A graphic for Section 9, featuring the word "Section" in a bold, sans-serif font above a large, white, stylized number "9" set against a dark, textured background.

## Recycling

Ludlum Measurements, Inc. supports the recycling of the electronics products it produces for the purpose of protecting the environment and to comply with all regional, national and international agencies that promote economically and environmentally sustainable recycling systems. To this end, Ludlum Measurements, Inc. strives to supply the consumer of its goods with information regarding reuse and recycling of the many different types of materials used in its products. With many different agencies, public and private, involved in this pursuit it becomes evident that a myriad of methods can be used in the process of recycling. Therefore, Ludlum Measurements, Inc. does not suggest one particular method over another, but simply desires to inform its consumers of the range of recyclable materials present in its products, so that the user will have flexibility in following all local and federal laws.

The following types of recyclable materials are present in Ludlum Measurements, Inc. electronics products, and should be recycled separately. The list is not all-inclusive, nor does it suggest that all materials are present in each piece of equipment:

Batteries	Glass	Aluminum and Stainless Steel
Circuit Boards	Plastics	Liquid Crystal Display (LCD)

Ludlum Measurements, Inc. products which have been placed on the market after August 13, 2005 have been labeled with a symbol recognized internationally as the “crossed-out wheelie bin” which notifies the consumer that the product is not to be mixed with unsorted municipal waste when discarding; each material must be separated. The symbol will be placed near the AC receptacle, except for portable equipment where it will be placed on the battery lid.

The symbol appears as such:





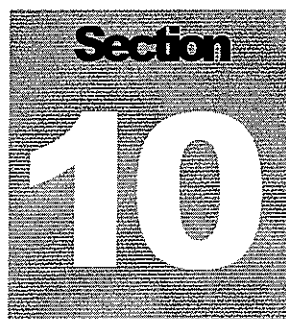

**Section**  
**10**

## Parts List

	<u>Reference</u>	<u>Description</u>	<u>Part Number</u>
<b>Model 177 Alarm Ratometer</b>	UNIT	Completely Assembled Model 177 Alarm Ratometer	48-1632
<b>Main Board, Drawing 347 x 227</b>	BOARD	Completely Assembled Circuit Board	5347-293
CAPACITORS	C001	10UF, 20V,	04-5655
	C011	47PF, 100V	04-5660
	C012	68UF, 6.3V	04-5654
	C021	0.1UF, 50V	04-5663
	C022	0.001UF, 100V	04-5659
	C023-C024	0.1UF, 50V	04-5663
	C025	10PF, 100V	04-5673
	C101	22UF, 10V	04-5672
	C111	0.022UF, 50V	04-5667
	C112	470PF, 100V	04-5668
	C121	0.001UF, 100V	04-5659
	C122	2.2UF, 20V	04-5671
	C123	1UF, 35V	04-5656
	C124	100PF, 3KV	04-5532
	C125	3300UF, 35V	04-5675
	C211	47UF, 10V	04-5666
	C221	0.0056UF, 3KV	04-5522
	C301-C302	47UF, 10V	04-5666
	C311-C312	0.01UF, 50V	04-5664
	C321	100PF, 3KV	04-5532
	C322	0.0056UF, 3KV	04-5522
C323	0.0047UF, 3KV	04-5547	

	<u>Reference</u>	<u>Description</u>	<u>Part Number</u>
	C401-C402	1UF, 35V	04-5656
	C403	0.1UF, 50V	04-5663
	C411	47UF, 10V	04-5666
	C421-C423	0.0047UF, 3KV	04-5547
TRANSISTORS	Q101	2N7002L	05-5840
	Q102	MMBT3904T	05-5841
	Q103	MJD210	05-5843
	Q104	MMBT3904T	05-5841
	Q111	MMBT3904T	05-5841
	Q301	MJD200	05-5844
	Q302	MMBT3904T	05-5841
	Q401	MJD210	05-5843
VOLTAGE REGULATOR	VR211	LM2931AT 5.0	05-5813
INTEGRATED CIRCUITS	U011	CD74HC4538M	06-6297
	U012	CA3096M	06-6288
	U021	TLC372ID	06-6290
	U111	ICM7555CBA	06-6300
	U121	CA3096M	06-6288
	U201	ICL7663SCBA	06-6302
	U301	LM285M-1.2	05-5845
	U311	TLC27M7ID	06-6292
DIODES	CR111-CR114	MMBD914L	07-6353
	CR201-CR202	CXSH-4	07-6358
	CR321	1N4007	07-6274
	CR401	MMBD914L	07-6353
	CR421-CR423	1N4007	07-6274
THERMISTOR	R314	250	07-6366
POTENTIOMETERS / TRIMMERS	R001	1M, HV TEST	09-6906
	R002	50K, BAT T	09-6920
	R013	50K, BAT C	09-6920

	<u>Reference</u>	<u>Description</u>	<u>Part Number</u>
RESISTORS			
	R003	475K, 1%, 125mW	12-7859
	R004	10.0, 1%, 125mW	12 7836
	R011	4.75K, 1%, 125mW	12-7858
	R012	82.5K, 1%, 125mW	12-7849
	R014-R015	100K, 1%, 125mW	12 7834
	R016	100, 1%, 125mW	12-7840
	R021-R022	10.0K, 1%, 125mW	12-7839
	R023	100K, 1%, 125mW	12-7834
	R024	1.00K, 1%, 125mW	12-7832
	R025	10.0K, 1%, 125mW	12-7839
	R026-R027	100K, 1%, 125mW	12-7834
	R028	10.0K, 1%, 125mW	12-7839
	R029	221K, 1%, 125mW	12-7845
	R0210	5.62K, 1%, 125mW	12-7871
	R101	1.00K, 1%, 125mW	12-7832
	R102	10.0K, 1%, 125mW	12-7839
	R103	100, 1%, 125mW	12-7840
	R111	1.00K, 1%, 125mW	12-7832
	R112	100K, 1%, 125mW	12-7834
	R113	1.00M, 1%, 125mW	12-7844
	R114	SAT, TYPICALLY 35.7K, 1%, 125mW	12-7911
	R115	100 OHM, 1%	12-7840
	R116	56.2K, 1%, 125mW	12-7873
	R117	1.00M, 1%, 125mW	12-7844
	R118	3.32K, 1%, 125mW	12-7870
	R121	3.92K, 1%, 125mW	12-7875
	R122	10.0K, 1%, 125mW	12-7839
	R123	100, 1%, 125mW	12-7840
	R124	392K, 1%, 125mW	12-7841
	R125	47.5K, 1%, 125mW	12-7872
	R126	100K, 1%, 125mW	12-7834
	R127	10.0K, 1%, 125mW	12-7839
	R128	221K, 1%, 125mW	12-7845
	R129	1M	10-7028
	R201	165K, 1%, 125mW	12-7877
	R202	1.00K, 1%, 125mW	12-7832
	R203	2.2, 5%, 125mW	12-7932
	R221	1M	10-7028
	R301	10.0K, 1%, 125mW	12-7839



	<u>Reference</u>	<u>Description</u>	<u>Part Number</u>
	R302	1.00K, 1%, 125mW	12-7832
	R303	2.21K, 1%, 125mW	12-7835
	R311	750K, 1%, 125mW	12-7882
	R312	301, 1%, 125mW	12-7863
	R313	475 ohm, 1%, 125mW	12-7851
	R315	22.1K, 1%, 125mW	12-7843
	R316	1.00M, 1%, 125mW	12-7844
	R321-R322	1G	12-7686
	R323	1M	10-7028
	R401	200, 1%, 125mW	12-7846
	R402	15, 1W	12-7738
TRANSFORMERS	T211	4275-083	4275-083
	T411	40-0902, 9=GND, 10=GND	40-0902
MISCELLANEOUS	P1	CONN-640445-3 MTA156	13-8125
	P2	CONN-1-640456-2 MTA100	13-8061
	P3	CONN-1-640456-0 MTA100	13-8066
	10 EA.	CLOVERLEAF RECEPT. 011-6809-000-599	18-8771
<b>Calibration Board, Drawing 347 x 132</b>	BOARD	Completely Assembled Calibration Board	5347-189
CAPACITORS	C1	0.0047UF, 100V	04-5570
	C2	0.047UF, 100V	04-5565
POTENTIOMETERS	R1	10K, RECORDER	09-6787
	R2	100K, HV	09-6813
	R3	1M, X1	09-6814
	R4	1M, X10	09-6814
	R5	2M, X100	09-6834
	R6	250K, X1000	09-6819
	R7	10K, DISCRIMIINATOR	09-6787

	<u>Reference</u>	<u>Description</u>	<u>Part Number</u>
RESISTOR	R9	680, 1/3W	12-7885
RESISTOR NETWORK	RN1	10K	12-7720
MISCELLANEOUS	P6	CONN 1-640457-1 MTA100	13 8397
<b>Wiring Diagram, Drawing 347 x 230</b>			
SWITCHES	S1	46206-LR SLIDE	08-6523
	S2	PA-1002	08-6543
	S3	7101-SYZ-QE	08-6511
	S4	HV (#923 SWITCHCRAFT)	08-6518
	S5	BAT (#923 SWITCHCRAFT)	08-6518
	S6	ALARM (#923 SWITCHCRAFT)	08-6518
	S7	RESET (30 1 PB GRAYHILL)	08-6517
POTENTIOMETERS	R1	10K, VOLUME	09-6753
	R2	100K, ALARM SET	09-6795
CONNECTORS	J1	MAIN BOARD 5347-293, 3 PIN SIP (CONN 640428-3 MTA 156)	13-8124
	J2	MAIN BOARD 5347-293, 12 PIN SIP (CONN 1-640441-2)	13-8431
	J3	MAIN BOARD 5347-293, 10 PIN SIP (CONN 1-640441-0MTA 100)	13-8197
	J4	ACRECEP (RECPT-AC W/FUSE)	13-8427
	J5	"D" CONN, 9 PIN (RECPT-RD9F000V3 9P)	13-8003
	J6	CALIBRATION BOARD 5347-189, 11 PIN SIP (CONN 1-640441-1 MTA 100)	13-8161
	J7	FLYING LEAD TO MAIN BOARD 5347-293 (RECPT-UG706)	13-7751

	<u>Reference</u>	<u>Description</u>	<u>Part Number</u>
AUDIO			
	DS2	UNIMORPH (TEC3526PU)	21-9251
BATTERY			
	B1	6V (PS610 GELL CELL)	21-9385
TRANSFORMER			
	T1	P6465	22-9908
MISCELLANEOUS			
	F1	1 AMP (FUSE #312001 AGC-1)	21-9277
	DS1	PILOT (LAMP-RED)	21-9296
	DS3	ALARM (BULB #338)	21-9307
	*	LAMP HOLDER	
		101-8430-09-201	21-9410
	M1	M177 METER	4173-166
	*	KNOB PKG-50B	08-6601
	*	KNOB-407D2KI	08-6604
	*	KNOB-LOCK KL 701	08-6607
	*	KNOB-70-1-2G	08-6637

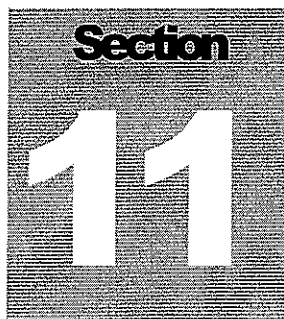

## Drawings

---

MAIN BOARD FOR HOYT 1mA/1K MOVEMENT, Drawing  
347 × 227

MAIN BOARD (HOYT 1mA/1K) Component Layout, Drawing  
347 × 228

CALIBRATION BOARD, Drawing 347 × 132

CALIBRATION BOARD Component Layout, Drawing 347 × 133

WIRING DIAGRAM FOR HOYT 1mA/1K MOVEMENT,  
Drawing 347 × 230



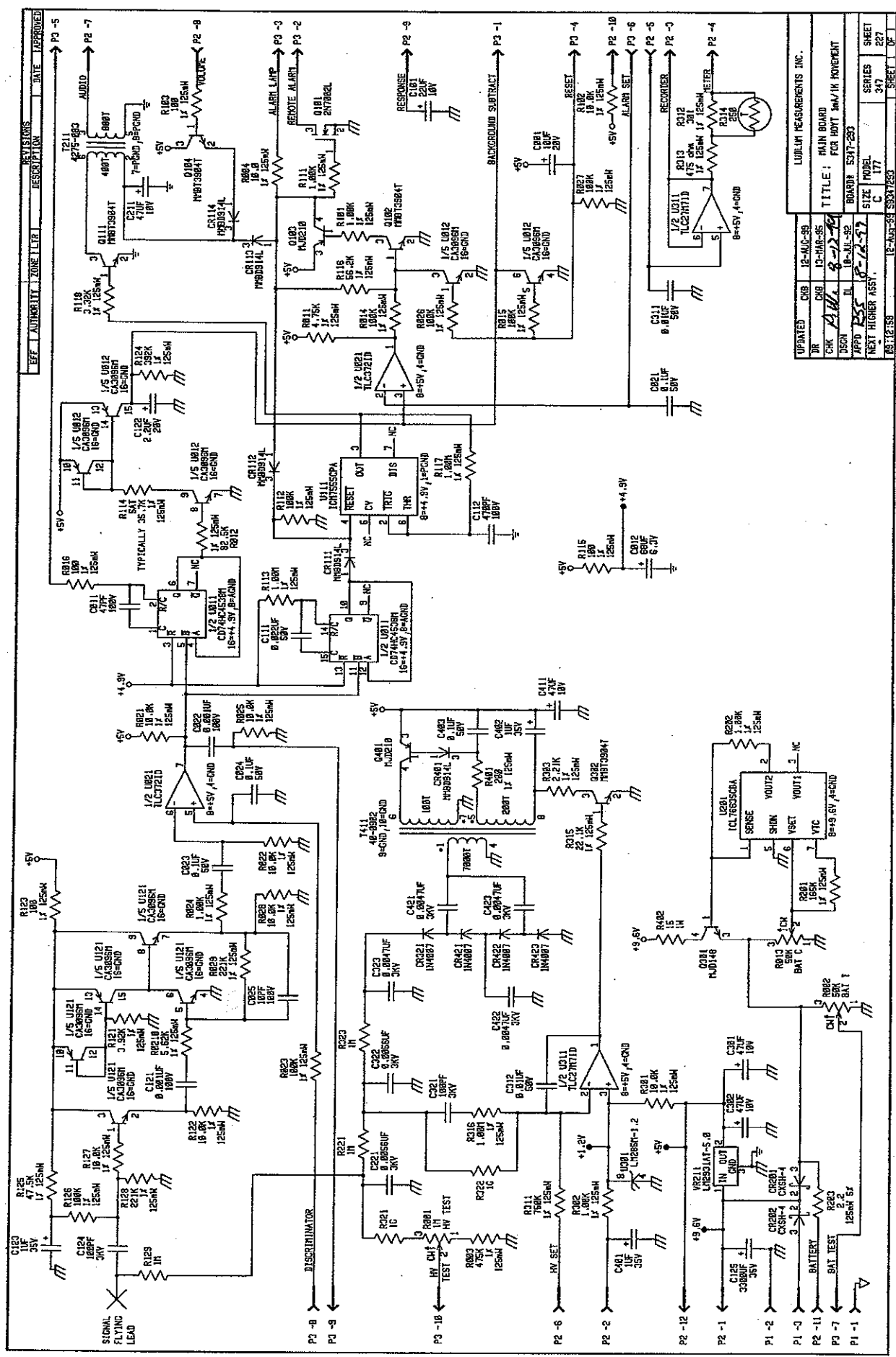

REV	AUTHORITY	ZONE	DATE	DESCRIPTION	DATE	APPROVED

UPDATER	CMB	12-AUG-88
DR	CMB	12-MAR-85
CHK	DL	8-12-84
DSGN	DL	18-JUL-82
APPR	DL	8-12-84
NEXT HIGHER ASSY		
P8112159		

LUBELIN MEASUREMENTS, INC.		
TITLE: MAIN BOARD		
FOR HOYT JAW/IK MOVEMENT		
BOARD: 53A7-230		
SIZE: MODEL C		
SHEET	347	OF
SHEET	227	OF

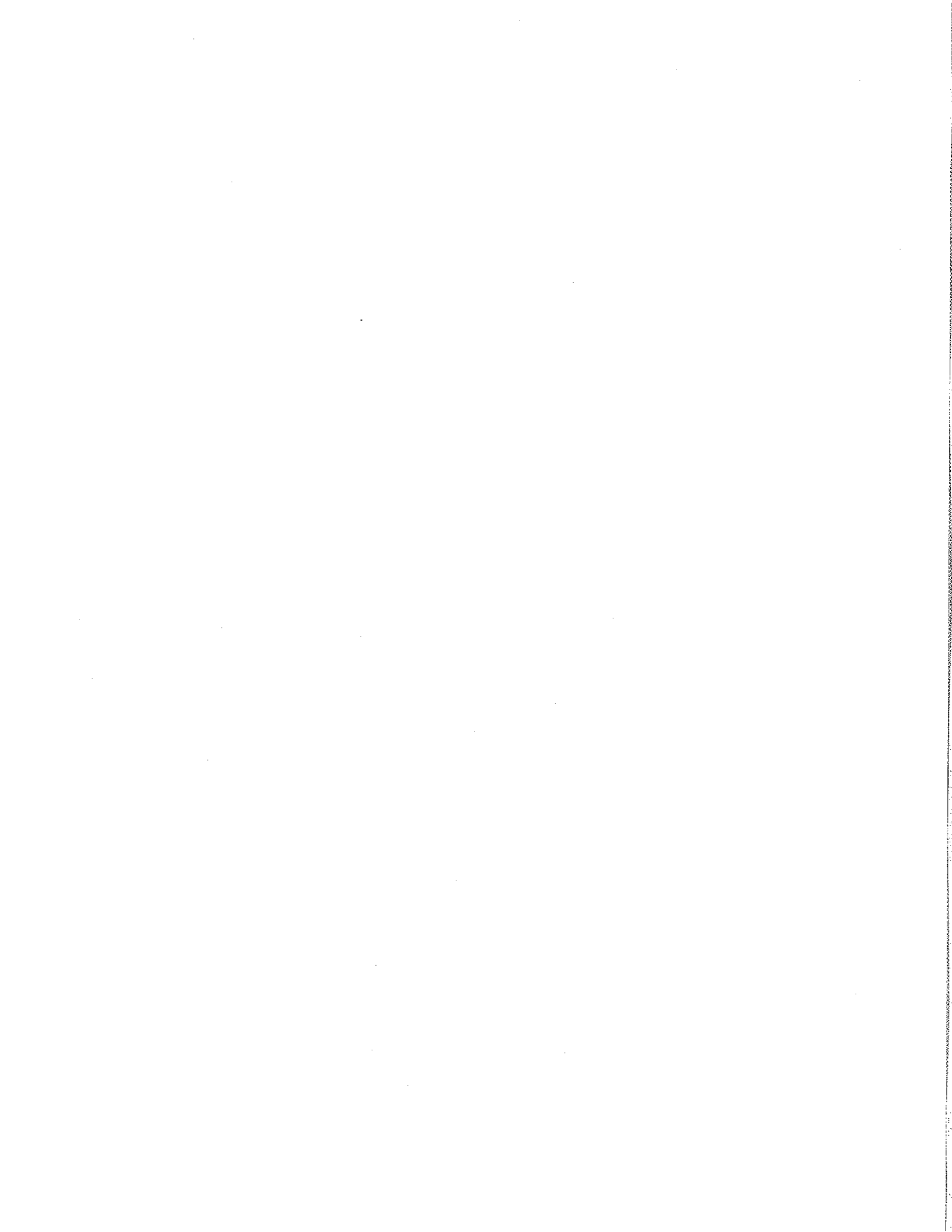

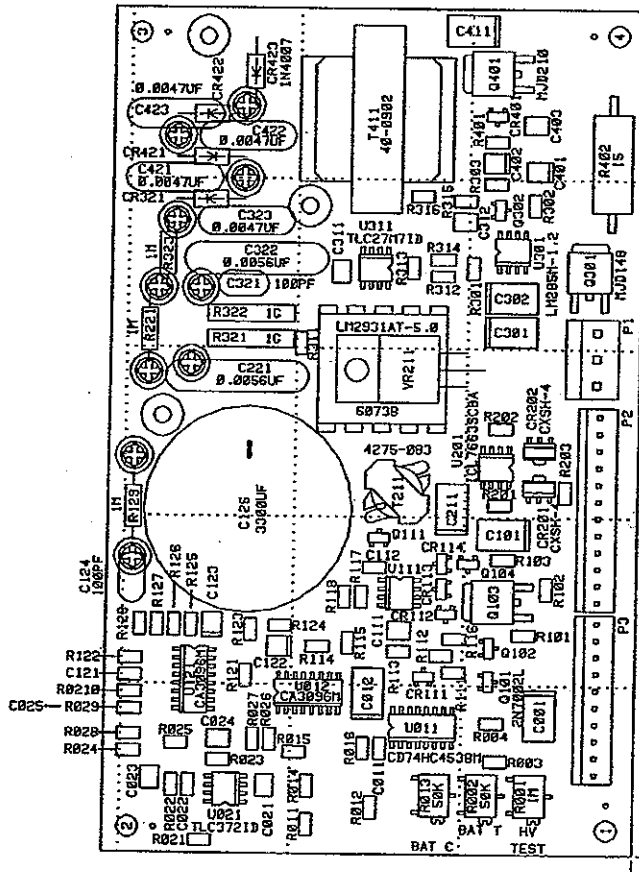

	LUDLUM MEASUREMENTS INC.	SHEETWATER, TX.
DR	CKB	03/12/95
CHK	P.L.	2/19/97
TITLE:	MAIN BOARD (MOT IMV/IK)	BS247293
ISSN	DL	07/18/92
MODEL	177	SERIES 347
SHEET	238	
APP	CLW	2/13/97
COMP	ARTWORK	
SLDR	ARTWORK	
SLDR	OUTLINE	
SLDR	OUTLINE	
SLDR	PASTE	
SLDR	PASTE	
SLDR	PASTE	









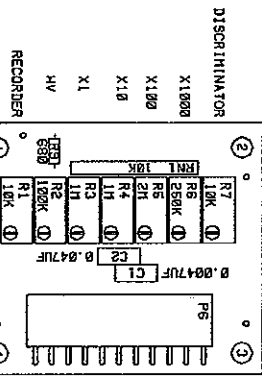

		LUDLUM MEASUREMENTS INC. SHEETPLATER, TX.	
DR	CRB 10/20/92	TITLE	CALIBRATION BOARD
CHK	DW	BOARD#	5347-1B9
DESIGN	6-10-92	MODEL	177
APP	JGW	SERIES	347
14:19:19	10-Jun-92	SHEET	133
COMP PASTE	COMP TASK	SLDR PASTE	SLDR TASK

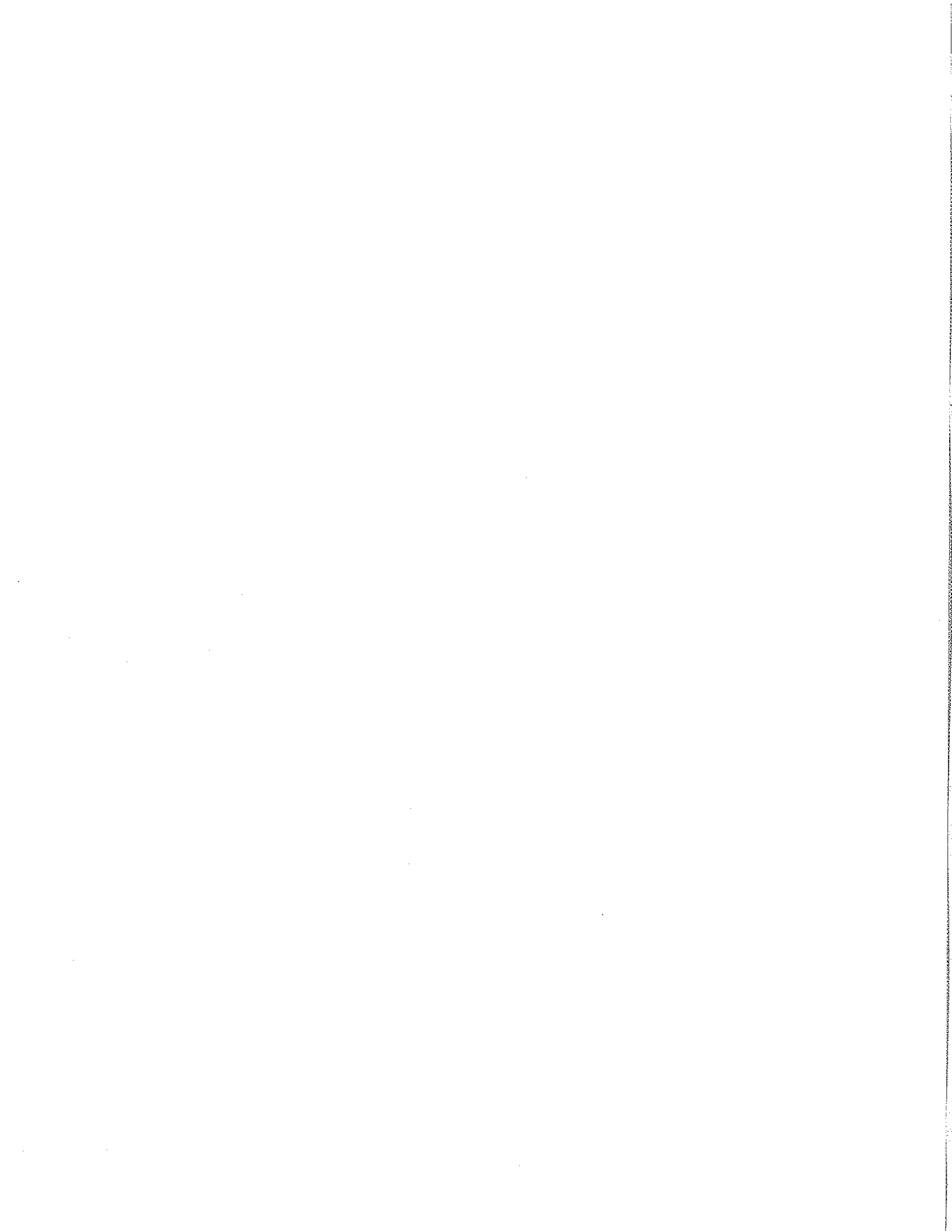

REV	AUTHORITY	DATE	DESCRIPTION	DATE	APPROVED

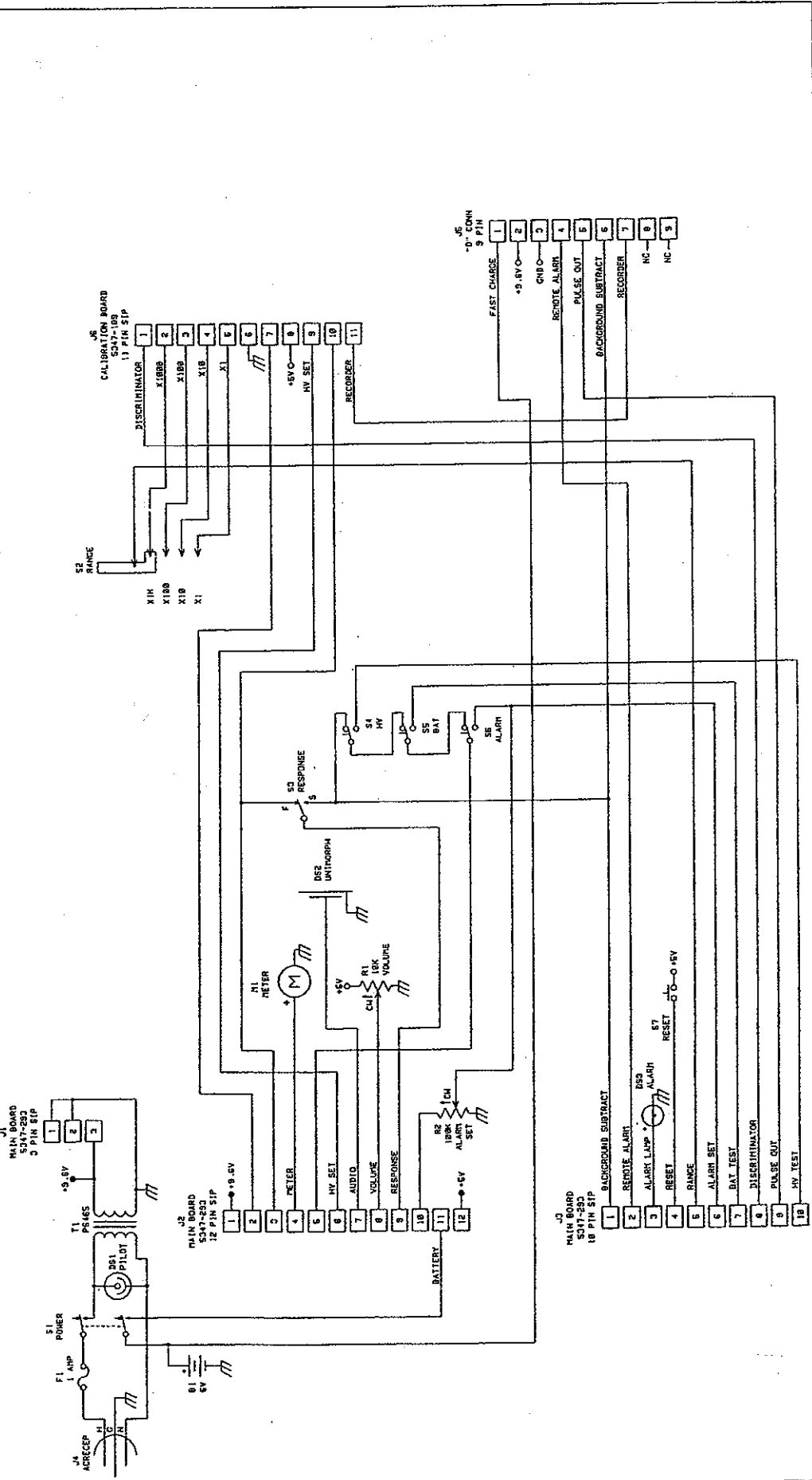

DR. CIP	02/12/85	TITLE: WIRING DIAGRAM
CHK: JGA	07/18/82	FOR PART 144/144 INCIDENT
ISSN: R	07/18/82	BOARD: 347-284
APPD: JG L	7/19/83	MODEL: 177
NET: RICHER ASST.		SIZE: 247
13-15-148	13-14-83	208
		SHEET 1
		OF 1

LUDLON MEASUREMENTS INC.  
 13-15-148  
 13-14-83  
 177  
 247  
 208  
 SHEET 1 OF 1



J7  
 FLYING LEAD TO  
 MAIN BOARD 5347-283

